



**35** años AHORRANDO  
ENERGÍA

CATÁLOGO  
**2023**























Somos una empresa mexicana certificada con ISO9001:2015, dedicada a la fabricación de Luminarias LED de alta eficiencia.

Con más de 35 años de experiencia estamos comprometidos en ofrecerte las soluciones de iluminación mejor orientadas a la eficiencia energética; que, además de brindarte un ahorro económico, logremos en conjunto, reducir nuestra huella de carbono.

# ÍNDICE

## LUMINARIAS LED PARA USO EN EXTERIORES

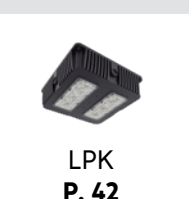
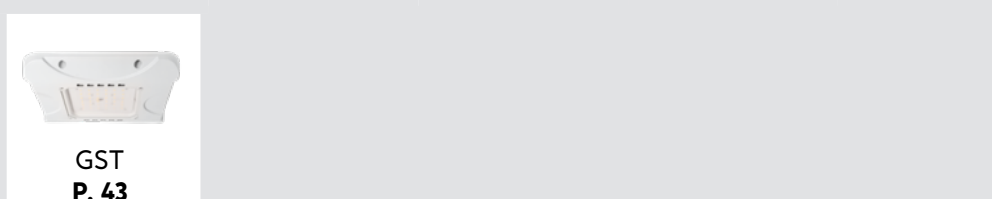
 <p>SLX P. 2</p>	 <p>HSSL4 P. 5</p>	 <p>HSSL P. 6</p>	 <p>ESTUDIOS FOTOMÉTRICOS P. 7</p>	 <p>ATLAS P. 8</p>	 <p>GSB P. 10</p>			
 <p>FUN P. 12</p>	 <p>GIZA P. 15</p>	 <p>TRIA P. 16</p>	 <p>SRL P. 19</p>	 <p>CLN P. 20</p>	 <p>SG-XT P. 23</p>			
 <p>GMPE P. 24</p>	 <p>WPL-F P. 26</p>	 <p>HRGL P. 29</p>	 <p>WPL-G P. 30</p>	 <p>WPL-C P. 31</p>	 <p>WPL-E P. 32</p>			
 <p>SLED-830-XT P. 34</p>			 <p>SLED-830-XT P. 37</p>			 <p>SLED880XT P. 38</p>		
 <p>LPK P. 42</p>	 <p>GST P. 43</p>							





















# ÍNDICE

## LUMINARIAS LED PARA ALTO MONTAJE E INDUSTRIA

 <p><b>HCX</b> <b>P. 44</b></p>	 <p><b>HBX</b> <b>P. 48</b></p>	 <p><b>HBL-G2</b> <b>P. 50</b></p>	 <p><b>HBL-G4</b> <b>P. 54</b></p>	 <p><b>HBL-G6</b> <b>P. 56</b></p>	 <p><b>HLX</b> <b>P. 58</b></p>
 <p><b>HB5</b> <b>P. 60</b></p>	 <p><b>PV900</b> <b>P. 62</b></p>	 <p><b>PV400</b> <b>P. 65</b></p>	 <p><b>PV200L</b> <b>P. 66</b></p>	 <p><b>PV-XT</b> <b>P. 68</b></p>	 <p><b>SLSF</b> <b>P. 70</b></p>
 <p><b>SCL-191</b> <b>P. 72</b></p>	 <p><b>LIN</b> <b>P. 73</b></p>	 <p><b>SLL-114</b> <b>P. 74</b></p>	 <p><b>VAP</b> <b>P. 76</b></p>	 <p><b>CAL</b> <b>P. 78</b></p>	 <p><b>ÁREAS CLASIFICADAS</b> <b>P. 81</b></p>
 <p><b>PEL-A</b> <b>P. 82</b></p>	 <p><b>PEL-B</b> <b>P. 85</b></p>	 <p><b>PEL-C</b> <b>P. 86</b></p>	 <p><b>PEL-E</b> <b>P. 87</b></p>	 <p><b>PEL-G</b> <b>P. 88</b></p>	 <p><b>PEL-I</b> <b>P. 92</b></p>
 <p><b>PEL-K</b> <b>P. 94</b></p>					

# ÍNDICE

## INTERIOR DE USO COMERCIAL

 <p><b>SDL-380</b> <b>P. 96</b></p>	 <p><b>SDL-321</b> <b>P. 100</b></p>	 <p><b>SQR</b> <b>P. 101</b></p>	 <p><b>MARCO</b> <b>P. 102</b></p>	 <p><b>PLED</b> <b>P. 104</b></p>	 <p><b>SDQ</b> <b>P. 108</b></p>
 <p><b>WRAP</b> <b>P. 110</b></p>	 <p><b>SLL-360</b> <b>P. 112</b></p>	 <p><b>SPD</b> <b>P. 114</b></p>	 <p><b>SPT</b> <b>P. 117</b></p>	 <p><b>UNIK</b> <b>P. 118</b></p>	 <p><b>LTC</b> <b>P. 120</b></p>
 <p><b>HBF</b> <b>P. 122</b></p>	 <p><b>HBK</b> <b>P. 123</b></p>	 <p><b>MALL</b> <b>P. 124</b></p>	 <p><b>CC-SE-900L</b> <b>P. 125</b></p>	 <p><b>CC-SE-860L</b> <b>P. 126</b></p>	 <p><b>CC-SE-100L</b> <b>P. 126</b></p>
 <p><b>CC-SE-600L</b> <b>P. 127</b></p>	 <p><b>CC-SE-500L</b> <b>P. 127</b></p>				

## SOLUCIONES DE AUTOMATIZACIÓN

 <p><b>SupraLink</b></p>  <p><b>P. 128</b></p>		 <p><b>SLSW</b> <b>P. 130</b></p>
		 <p><b>SENSORES DE PRESENCIA</b> <b>P. 132</b></p>

# ÍNDICE

## LÍNEA ARQUITECTÓNICA

 <p>LIZ10 P. 134</p>	 <p>LIZ20 P. 136</p>	 <p>LIZ30 P. 137</p>	 <p>LIZ40 P. 138</p>	 <p>LIZ60 P. 139</p>	 <p>LIZ50 P. 140</p>
 <p>TOM40 P. 142</p>	 <p>TOM10 P. 144</p>	 <p>TOM20 P. 144</p>	 <p>TOM30 P. 145</p>	 <p>CLARTÉ® P. 146</p>	

## LÁMPARAS GERMICIDAS

 <p>LUZ UV-C P. 153</p>	 <p>HEALIX-UV P. 154</p>	 <p>UVC-MOV P. 154</p>	 <p>UVC-HB P. 155</p>	 <p>UVC-LB P. 155</p>	 <p>SLUV-410C P. 156</p>
 <p>UVC-AIR P. 156</p>	 <p>UVC-UP P. 156</p>				

# ÍNDICE

## SISTEMAS FOTOVOLTAICOS



**Hsll Solar**  
**P. 158**



**SUP**  
**P. 160**



**GRETA**  
**P. 162**



**SUNEL**  
**P. 164**



**CARPORT**  
**P. 166**



**MONOPOSTE**  
**P. 167**



**SOLUCIONES**  
**P. 168**

# SIMBOLOGÍA



GRADO DE PROTECCIÓN



PROTECCIÓN CONTRA IMPACTOS



TEMPERATURA DE COLOR



VOLTAJE DE OPERACIÓN



EMPOTRAR EN TECHO



EMPOTRAR EN PARED



EMPOTRAR EN PISO



SOBREPONER EN TECHO



SOBREPONER EN PARED



SUSPENDER



VIALIDAD



ÁREAS VERDES



CANCHAS DEPORTIVAS



EXTERIOR DECORATIVO



ESTACIONAMIENTO ABIERTO



ESTACIONAMIENTO TECHADO



AEROPUERTO Y PUERTOS



MANUFACTURA



GASOLINERAS



CUARTOS LIMPIOS



ALMACÉN



INDUSTRIA ALIMENTICIA



INDUSTRIA PETROQUÍMICA



INDUSTRIA AUTOMOTRIZ



LUMINARIA DE EMERGENCIA



INTERIOR DECORATIVO



GIMNASIO



PASILLO



OFICINA



RESTAURANTE



HOSPITAL



TIENDA DE CONVENIENCIA



BOUTIQUE



SUPERMERCADO



CENTROS DE EDUCACIÓN



## SLX



Luminaria LED de alta eficiencia diseñada para iluminar vialidades y áreas públicas en general, ideal por su bajo deslumbramiento conforme a los niveles indicados en la NOM.

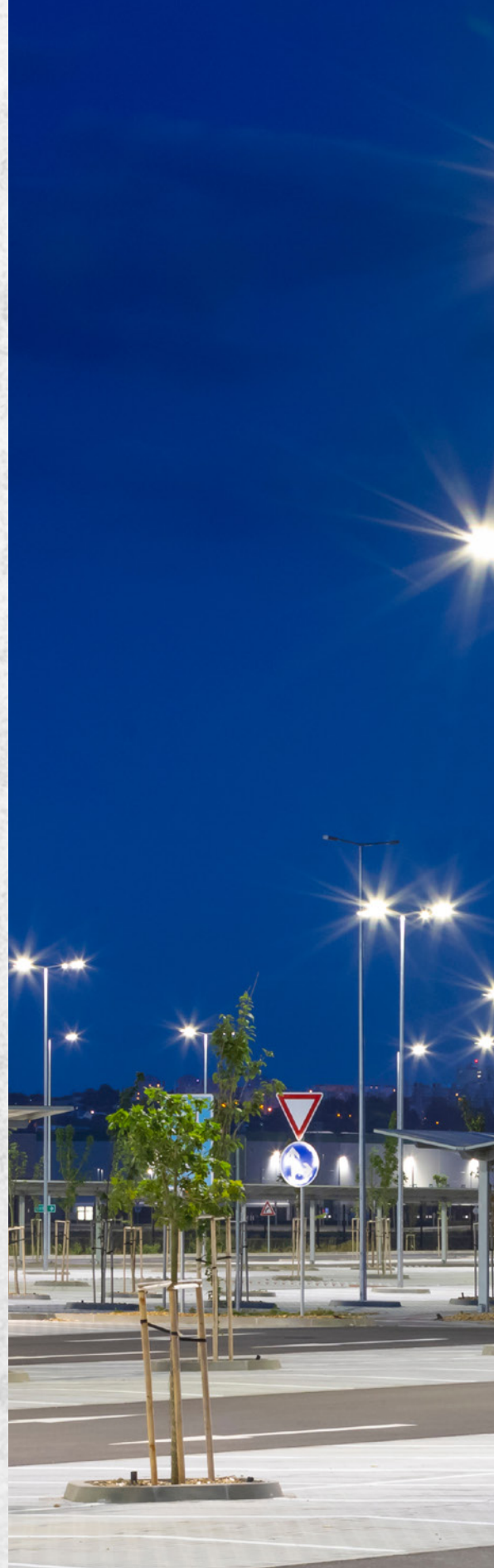

IP66

IK09

100-277  
VAC

4000-  
5000 K



# SLX



NOM-031-ENER-2012  
 NOM-003 -SCFI-2014  
 NMX-D-122-1973

## CARACTERÍSTICAS

POTENCIAS	30W, 40W, 50W, 60W, 80W, 100W, 150W, 180W
RANGO DE LÚMENES	4,500 - 28,196
IRC	≥70
PROTECCIÓN	IP66
VOLTAJE	100 - 277 V~
COLOR	4000 y 5000 K
GARANTÍA	10 años

## DIMENSIONES

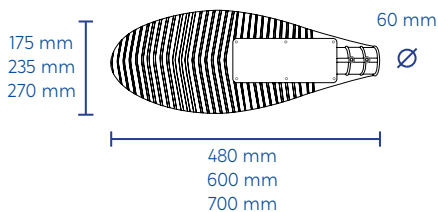

## ACCESORIOS

- Base para Fococelda (fig. 1)
- Fococelda de 3 y 7 pines
- Brazo de ángulo ajustable



fig.1

## TIPOS DE CURVA

Curva Tipo 2 (T2)

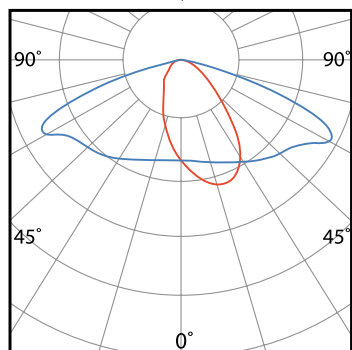

cd/klm — C0 - C180 — C90 - C270

## DISIPADOR DE CALOR



# HSL4



ALTA EFICIENCIA

## CARACTERÍSTICAS

POTENCIAS	28W, 40W, 45W, 56W, 61W, 72W, 78W, 90W, 96W
RANGO DE LÚMENES	4,200 - 12,800
IRC	≥70
PROTECCIÓN	IP65 IK10
VOLTAJE	120 - 277 V~
COLOR	5000 K
GARANTÍA	10 años

## DIMENSIONES

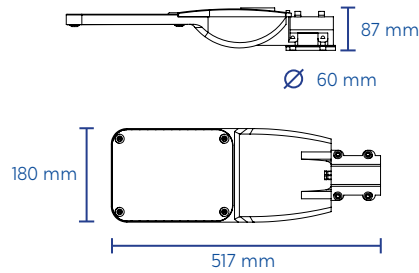

## ACCESORIOS

- Fococelda
- Brazo Shoebox para pared y para poste (fig 1 y 2)



## TIPOS DE CURVA

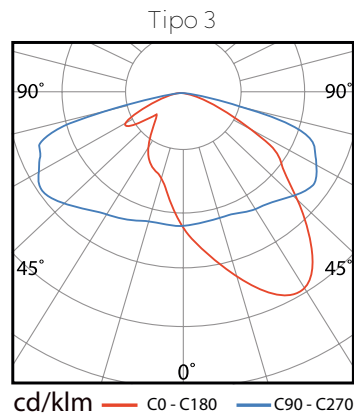
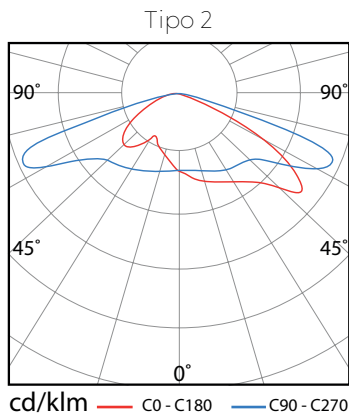

# HSL



## CARACTERÍSTICAS

POTENCIAS	49W, 69W, 83W, 104W, 130W, 163W, 198W
RANGO DE LÚMENES	4,900 - 20,200
IRC	≥70
PROTECCIÓN	IP65 IK08
VOLTAJE	120 - 277 V~
COLOR	5000 K
GARANTÍA	10 años

## DIMENSIONES

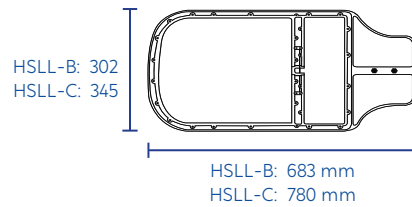
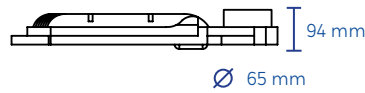

## ACCESORIOS

- Fococelda (fig. 1)
- Brazo de ángulo ajustable



fig.1

## TIPOS DE CURVA

Curva Tipo II Media

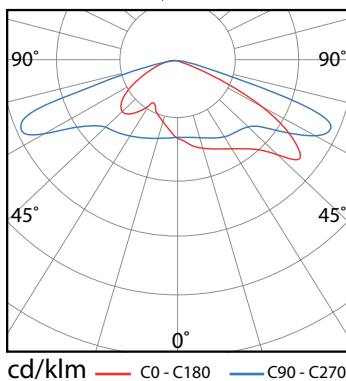

Con más de 250,000 luminarias instaladas en toda la república, HSL se posiciona como una de las lámparas de vialidad hechas en México con mayor demanda.

## ESTUDIOS FOTOMÉTRICOS

Brindamos asesoría y estudios fotométricos sin costo para ofrecerte la mejor solución en iluminación, de acuerdo a tus necesidades.

Nos especializamos en productos y servicios de ahorro de energía, empleando componentes de la más alta calidad para ofrecer amplias garantías.

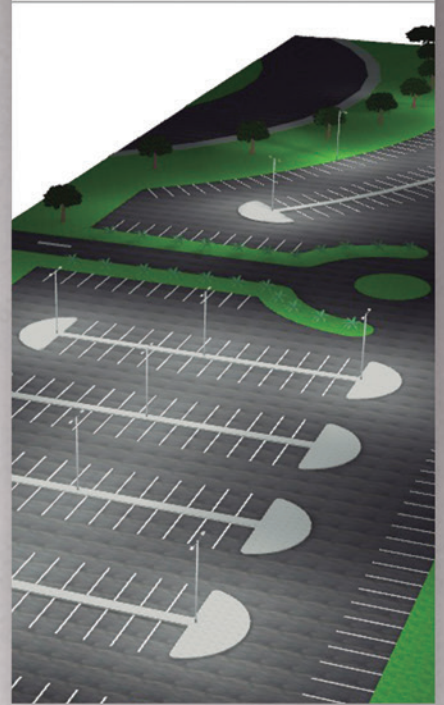

# ATLAS (ATL)

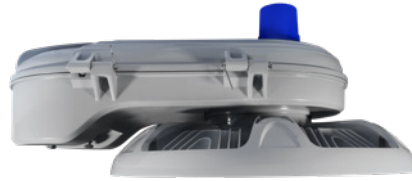

## CARACTERÍSTICAS

POTENCIAS	240W, 475W, 750W
RANGO DE LÚMENES	33,600 - 97,500
IRC	≥70
PROTECCIÓN	IP66 IK08
VOLTAJE	120 - 277 V~
COLOR	5000 K
GARANTÍA	10 años

## DIMENSIONES

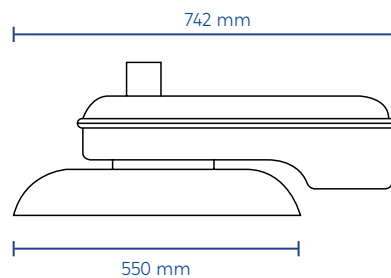

## ACCESORIOS

- Fococelda

## INCLINACIÓN

Ajuste el ángulo de su preferencia, ATLAS permite una inclinación de 0° a 7°.

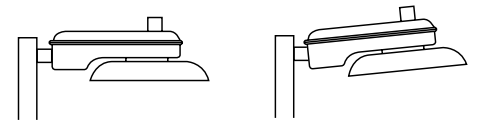

## TIPOS DE CURVA

TIPO 60G

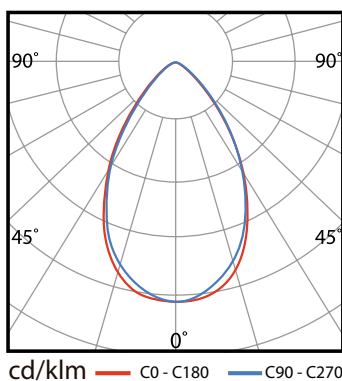

TIPO 4

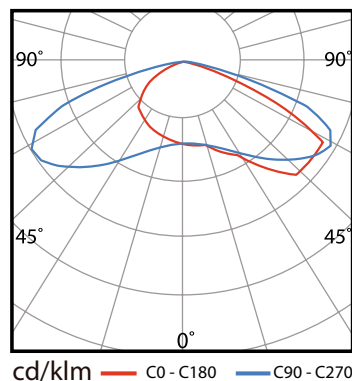

TIPO 5

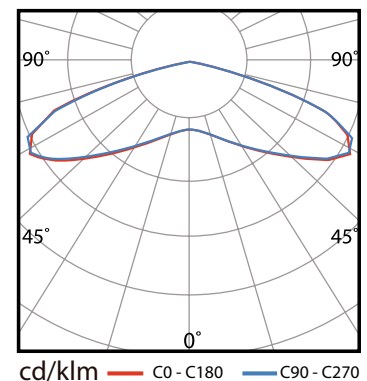

IP66

IK08

120-277  
VAC

5000K





# GSB



## CARACTERÍSTICAS

POTENCIAS	40W, 80W, 120W
RANGO DE LÚMENES	4,900 - 14,500
IRC	≥70
PROTECCIÓN	IP65
VOLTAJE	120 - 277 V~
COLOR	5000 K
GARANTÍA	10 años

## DIMENSIONES

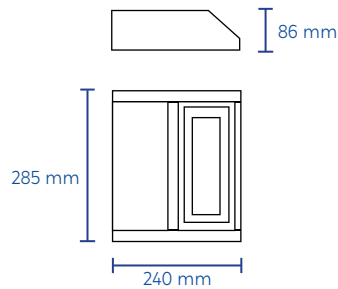

Ejemplo modelo de 40W

## ACCESORIOS

- Brazo de ángulo ajustable (fig. 1)



fig. 1

## TIPOS DE CURVA

Curva 30°

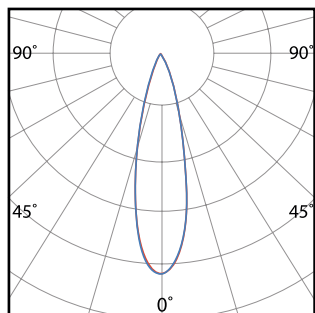

cd/klm — C0 - C180 — C90 - C270

Curva 60°

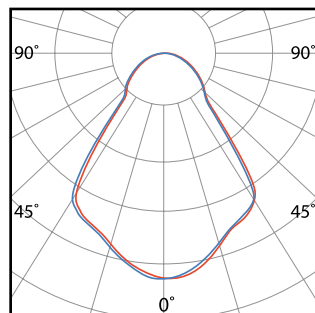

cd/klm — C0 - C180 — C90 - C270

Curva 90°

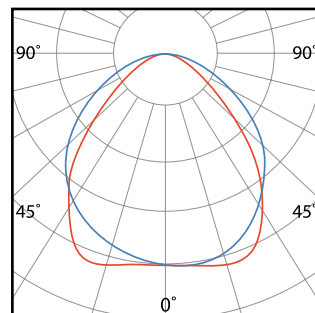

cd/klm — C0 - C180 — C90 - C270

Curva Tipo II Media

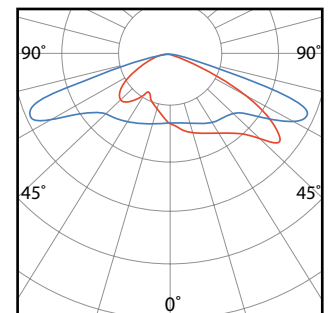

cd/klm — C0 - C180 — C90 - C270

IP65

IK08

120-277  
VAC

5000K

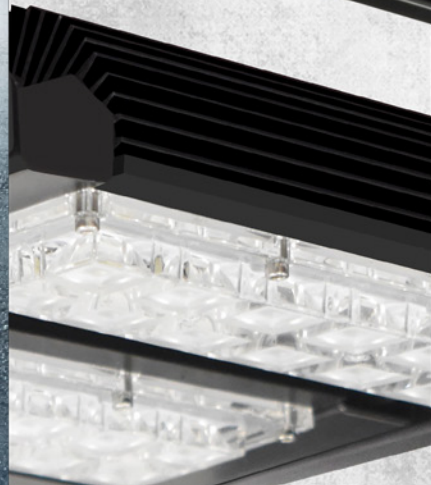

## FUN



Punta de poste LED de aluminio, diseño minimalista con carcasa sellada, cuenta con tecnología de doble difusor para brindar un buen nivel de iluminación uniforme con poco deslumbramiento.

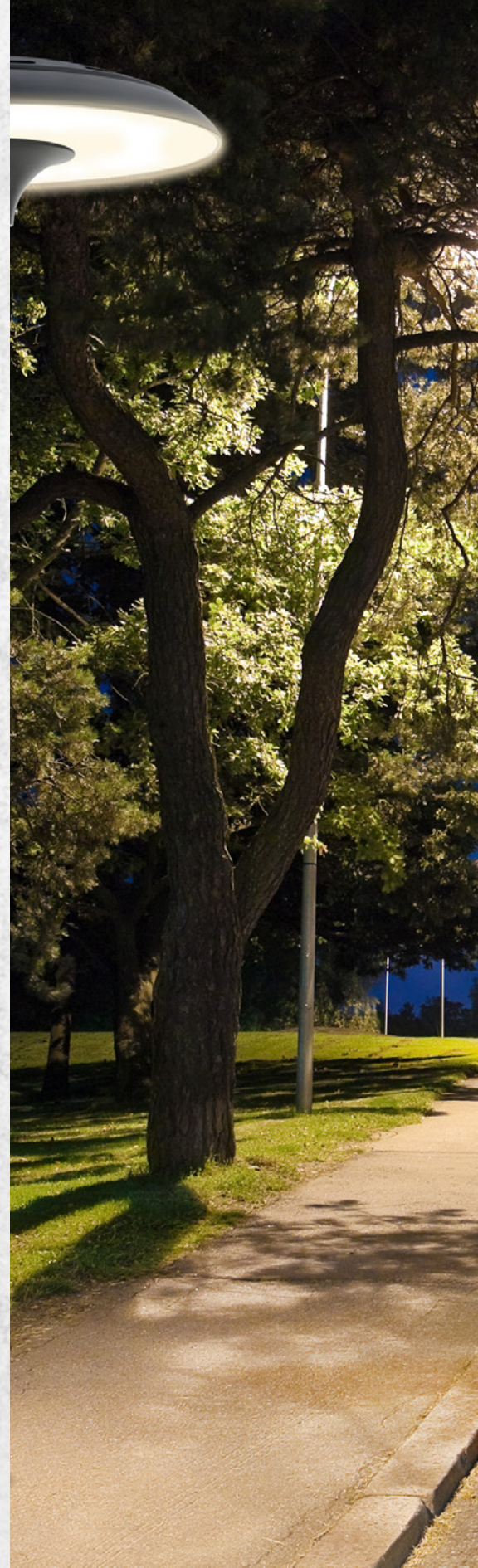



# FUN



## CARACTERÍSTICAS

POTENCIA	60W
LÚMENES	6,000
IRC	≥70
PROTECCIÓN	IP65
VOLTAJE	110 - 277 V~
COLOR	3000 K, 4000 K 6000 K
GARANTÍA	7 años

## DIMENSIONES

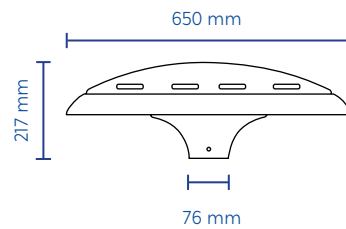

## INSTALACIÓN



## TIPO DE CURVA

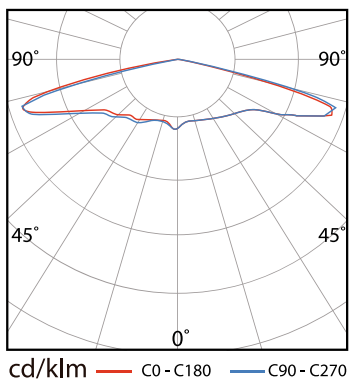

## GIZA

**NOM**

## CARACTERÍSTICAS

POTENCIA	60W
LÚMENES	5,300
IRC	≥70
PROTECCIÓN	IP54
VOLTAJE	120 - 277 V~
COLOR	5000 K
GARANTÍA	7 años

## DIMENSIONES

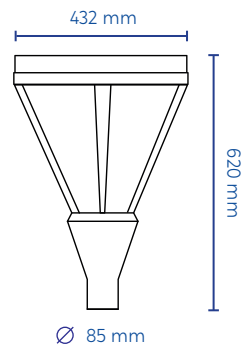

## INSTALACIÓN



## TRIA



Luminaria LED punta de poste, con diseño en forma de triángulo circular que distribuye la luz eficientemente gracias a sus reflectores integrados, te ofrece una apariencia moderna con su diseño vanguardista.







# TRIA



## CARACTERÍSTICAS

POTENCIAS	56W y 85W
RANGO DE LÚMENES	4,700 y 7,200
IRC	≥70
PROTECCIÓN	IP65
VOLTAJE	86 - 264 V~
COLOR	6000 K
GARANTÍA	7 años

## DIMENSIONES

MODELO DE 56W

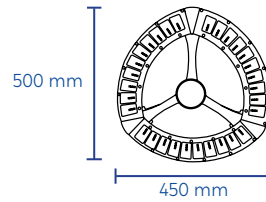

MODELO DE 85W

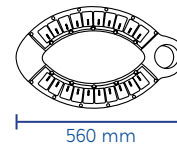

## INSTALACIÓN



# SRL



## CARACTERÍSTICAS

POTENCIAS	60W, 80W, 100W
RANGO DE LÚMENES	6,000 - 10,000
IRC	≥70
PROTECCIÓN	IP52
VOLTAJE	120 - 277 V~
COLOR	5000 K
GARANTÍA	7 años

## DIMENSIONES

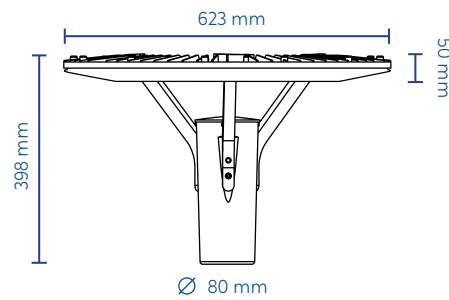

## INSTALACIÓN



## COLONIAL (CLN)



Luminaria punta de poste ideal para áreas donde se requiera un diseño colonial para mantener armonía con el ambiente y obtener buenos niveles de iluminación.





IP65

120-277  
VAC

5000K



# COLONIAL (CLN)

**NOM**

## CARACTERÍSTICAS

POTENCIAS	74W, 62W, 52W, 42W, 31W
RANGO DE LÚMENES	2,800 - 6,800
IRC	≥80
PROTECCIÓN	IP65
VOLTAJE	120 - 277 V~
COLOR	3000, 4000 y 5000 K
GARANTÍA	10 años

## DIMENSIONES

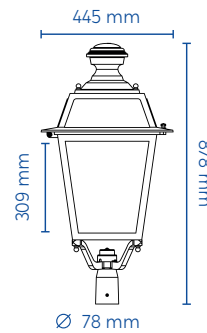

## ACCESORIOS

- Brazo para instalar (diseño personalizable) (fig.1)
- Poste con entrada de 80 mm



fig.1

## OPCIONES DE INSTALACIÓN

Punta de poste

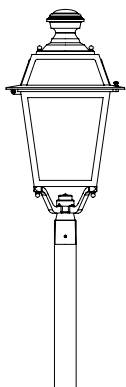

En brazo

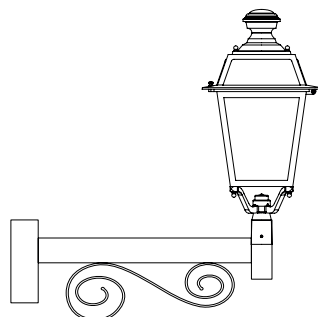

En brazo colgante

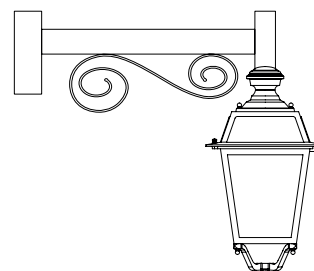

Suspendido

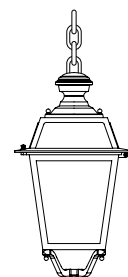

## SG-XT

**NOM**

## CARACTERÍSTICAS

POTENCIAS	30W y 58W
RANGO DE LÚMENES	2,500 y 4,770
IRC	≥73
PROTECCIÓN	IP65
VOLTAJE	120 - 277 V~
COLOR	5000 K
GARANTÍA	10 años

## DIMENSIONES

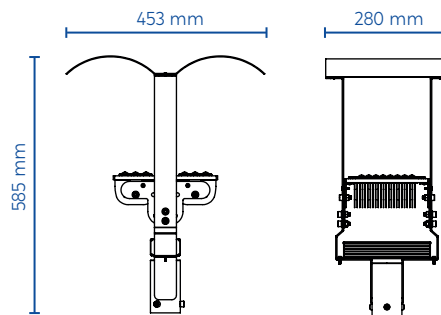

## ACCESORIOS

- Requiere poste de 80 mm



# GMPE



## CARACTERÍSTICAS

POTENCIAS	32W, 49W, 64W, 83W
RANGO DE LÚMENES	4,390 - 10,600
IRC	≥80
PROTECCIÓN	IP65
VOLTAJE	120 - 277 V~
COLOR	5000 K
GARANTÍA	10 años

## DIMENSIONES

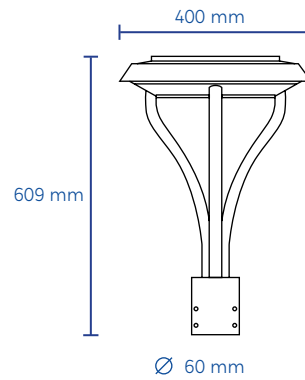

## INSTALACIÓN



## TIPOS DE CURVA

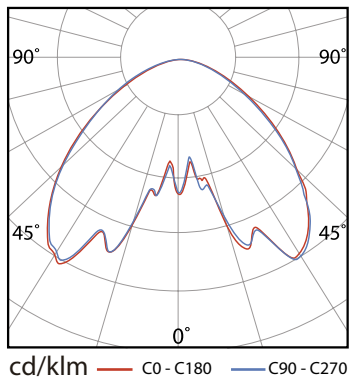

- IP65
- 120-277 VAC
- 3000K
- Light distribution icon
- Plant icon
- Bicycle icon
- Hand icon





## WPL-F



Luminaria de pared con curva de iluminación simétrica.  
Diseñada con disipadores de calor para asegurarse de extender la vida de sus componentes.

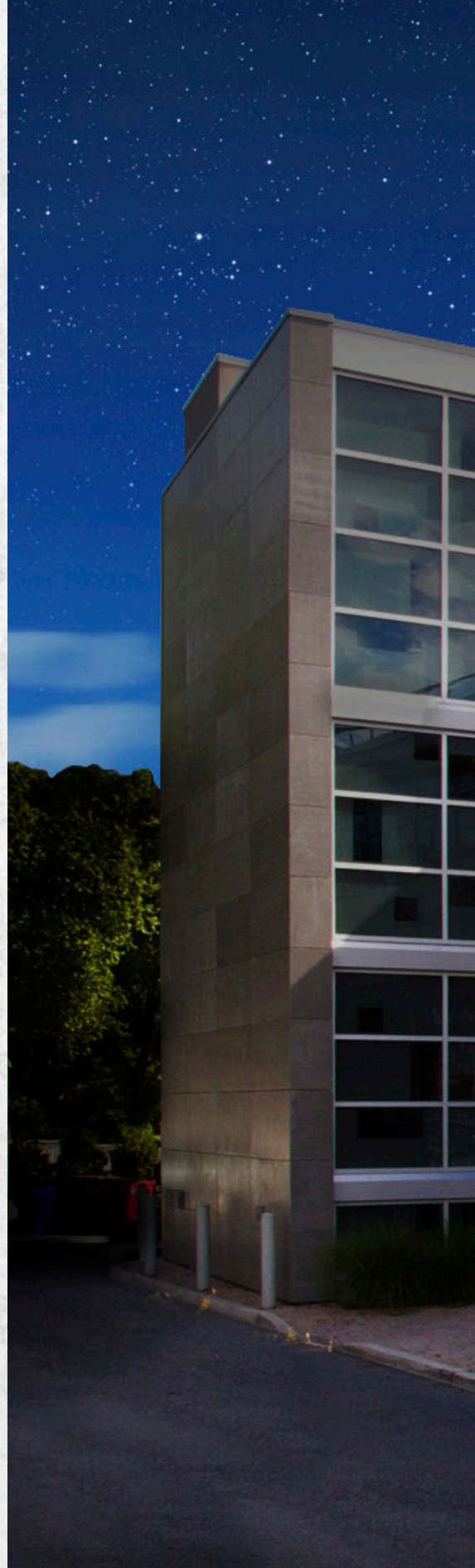



IP65

100-277  
VAC

5000K



# WPL-F



## CARACTERÍSTICAS

POTENCIAS	50W, 70W, 100W
RANGO DE LÚMENES	7,200 - 13,200
IRC	≥70
PROTECCIÓN	IP65
VOLTAJE	100 - 277 V~
COLOR	5000 K
GARANTÍA	7 años

## DIMENSIONES

MODELO DE 50W

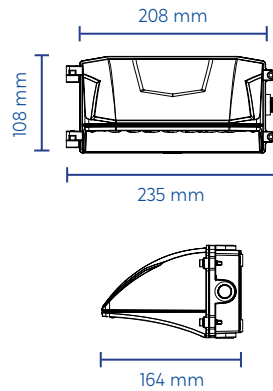

MODELO DE 70W y 100W

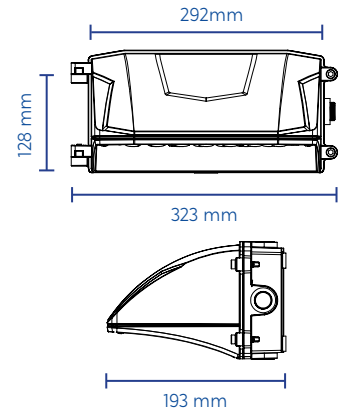

## TIPOS DE CURVA

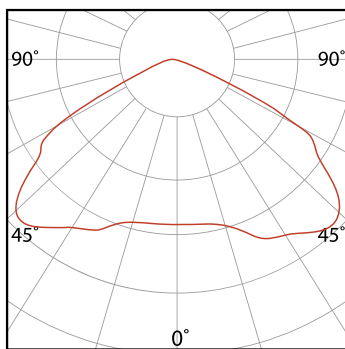

cd/klm — C0 - C180 — C90 - C270

## INSTALACIÓN

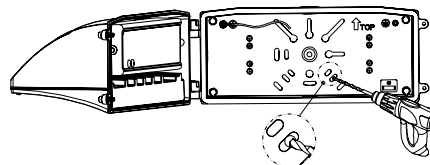

# HRGL



## NOM

### CARACTERÍSTICAS

POTENCIAS	41W
LÚMENES	4,300
IRC	≥82
PROTECCIÓN	IP54
VOLTAJE	100 - 277 V~
COLOR	5000 K
GARANTÍA	7 años

### DIMENSIONES

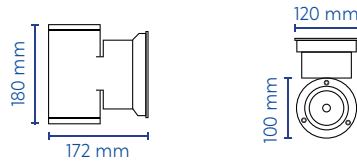

### INSTALACIÓN

Diseñado para sobreponer en pared.





# WPL-G

**NOM**

## CARACTERÍSTICAS

POTENCIAS	40W, 60W, 80W, 105W, 120W
RANGO DE LÚMENES	4,400 - 13,800
IRC	≥80
PROTECCIÓN	IP65
VOLTAJE	120 - 277 V~
COLOR	4000 y 5000 K
GARANTÍA	10 años

## DIMENSIONES

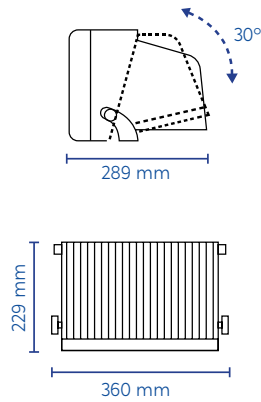

## INSTALACIÓN

- Diseñado para sobreponer



## TIPOS DE CURVA

Curva Tipo IV Media

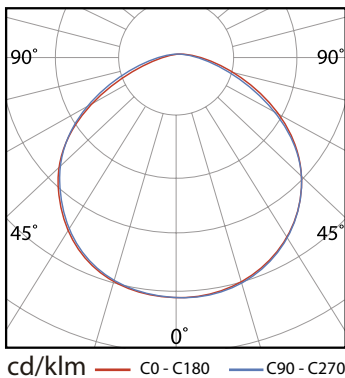



## WPL-C



# NOM

### CARACTERÍSTICAS

POTENCIAS	20W, 30W, 40W, 50W, 60W, 70W, 80W, 90W
RANGO DE LÚMENES	2,800 - 12,600
IRC	≥70
PROTECCIÓN	IP66
VOLTAJE	90 - 305 V~
COLOR	5000 K
GARANTÍA	7 años

### DIMENSIONES

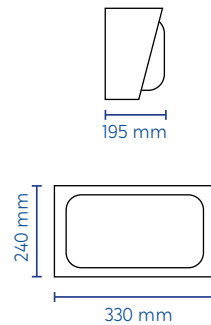

### INSTALACIÓN

- Diseñada para sobreponer en pared. Pieza frontal abatible para mantenimiento ó limpieza interior.



# WPL-E



**NOM**

## CARACTERÍSTICAS

POTENCIAS	25W, 50W, 70W
RANGO DE LÚMENES	2,500 - 7,000
IRC	≥80
PROTECCIÓN	IP65
VOLTAJE	120 - 277 V~
COLOR	5000 K
GARANTÍA	7 años

## DIMENSIONES

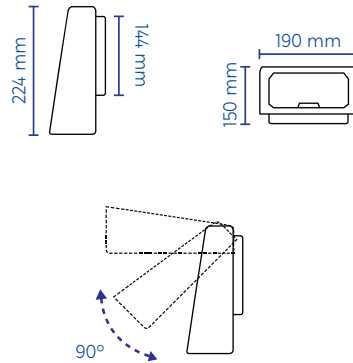

## INSTALACIÓN

- Diseñado para sobreponer



## TIPOS DE CURVA

90° Simétrica

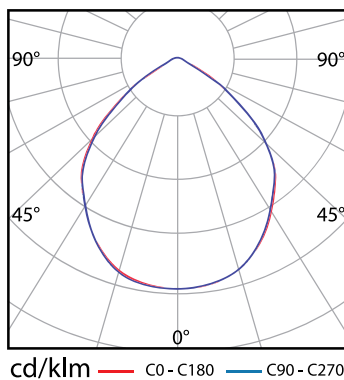



IP65

120-277  
VAC

5000K





## SLED-830-XT



Proyector LED de alta eficiencia, su versátil diseño permite dirigir cada módulo individualmente, además está fabricado para ofrecer una óptima disipación de calor, lo que lo hace ideal para áreas de altas temperaturas.





IP65

120-277  
VAC

5000K



# SLED-830-XT



## CARACTERÍSTICAS

POTENCIAS	45W, 92W, 120W, 160W, 261W
RANGO DE LÚMENES	5,100 - 28,500
IRC	≥80
PROTECCIÓN	IP65
VOLTAJE	120 - 277 V~
COLOR	5000 K
GARANTÍA	10 años

## DIMENSIONES

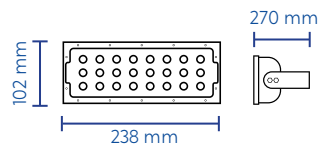

Ejemplo modelo de 45W

## TIPOS DE CURVA

- 30°
- 60°
- 90°

## ÁNGULOS DE ROTACIÓN

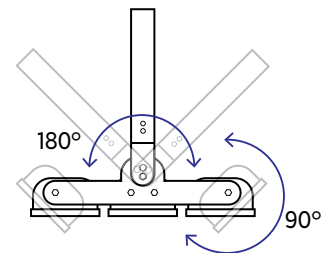

## OPCIONES DE INSTALACIÓN

Suspendida

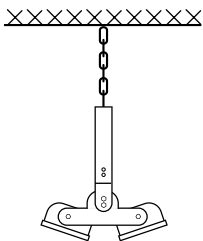

Montada en techo

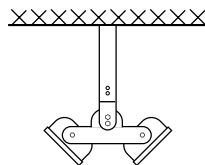

Instalada en piso

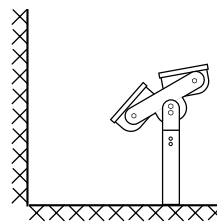

Montada en pared

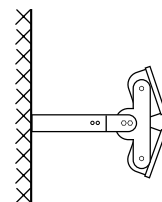

# SLED-830-XT

SLED-830-XT-50 y SLED-830-XT-100



SLED-830-XT-150 y SLED-830-XT-200



SLED-830-XT-300



SLED-830-XT-400



SLED-830-XT-600



## CARACTERÍSTICAS

POTENCIAS	50W, 100W, 150W, 200W, 300W, 400W, 600W
RANGO DE LÚMENES	8,500 - 102,000
IRC	≥80
PROTECCIÓN	IP65 - IK08
VOLTAJE	120 - 240 V~
COLOR	5000 K
GARANTÍA	10 años

## DIMENSIONES

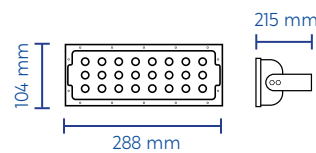

Ejemplo modelo de 50W

## TIPO DE CURVA

- 30°
- 60°
- 120°

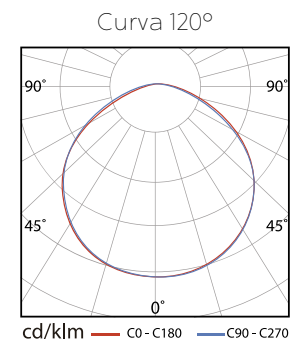

## SLED880XT



Proyector LED de gran alcance luminoso, diseño que permite el ajuste de módulos.

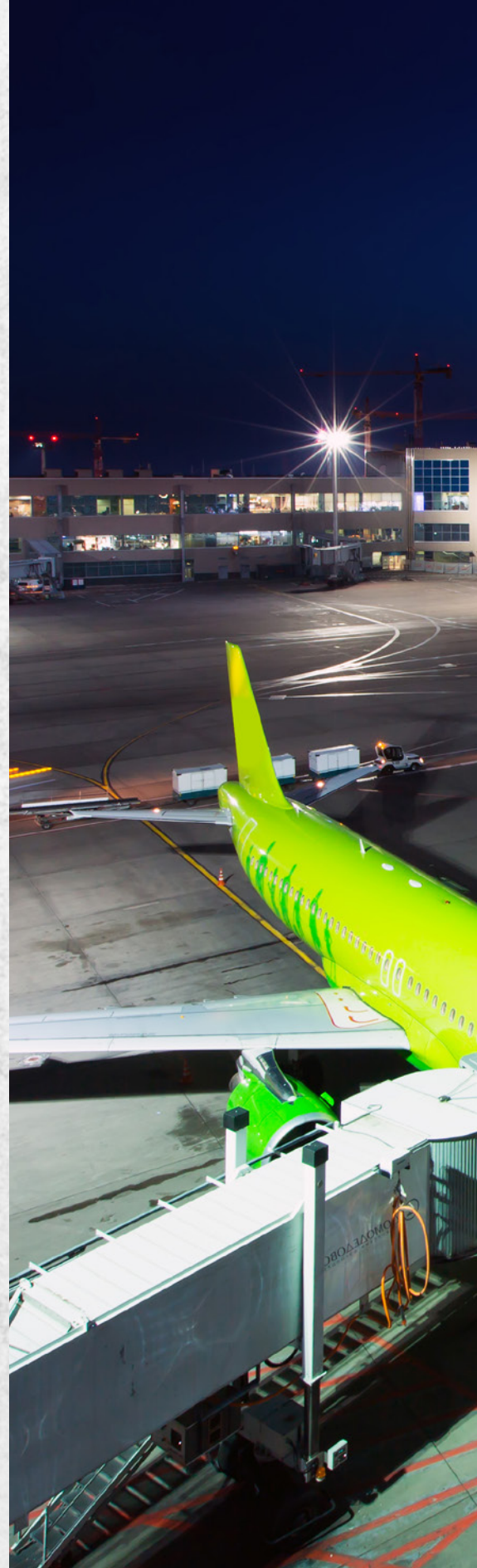

IP66

IK10

120-277  
VAC

5000K

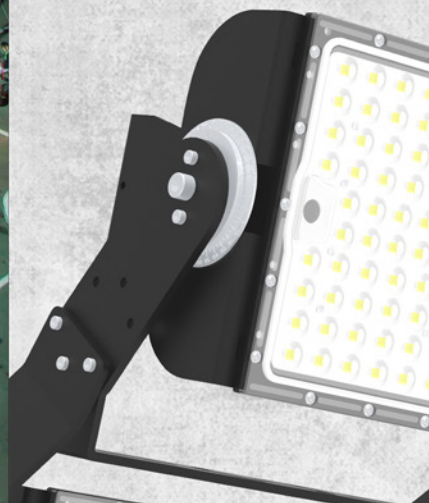

# SLED880XT

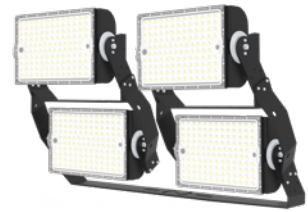

## CARACTERÍSTICAS

POTENCIAS	300W, 600W, 900W, 1200W
RANGO DE LÚMENES	51,000 - 204,000
IRC	≥70
PROTECCIÓN	IP66 -IK10
VOLTAJE	120 - 277 V~
COLOR	5000 K
GARANTÍA	10 años

## DIMENSIONES

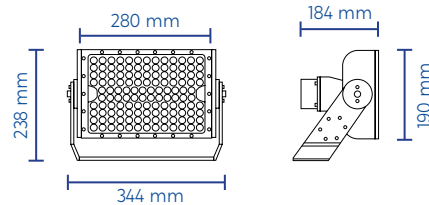

Ejemplo modelo de 300W

## ACCESORIOS

- Focelda
- Barrera de aluminio (fig. 1)
- Apuntador láser (fig. 2)

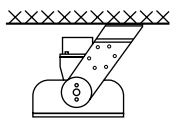

fig. 1

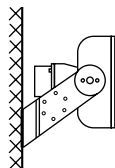

fig. 2

## OPCIONES DE INSTALACIÓN



Instalada en techo



Instalada en pared

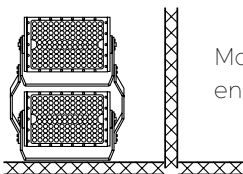

Montada en poste

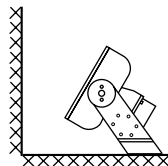

Sobre el piso

## TIPOS DE CURVA

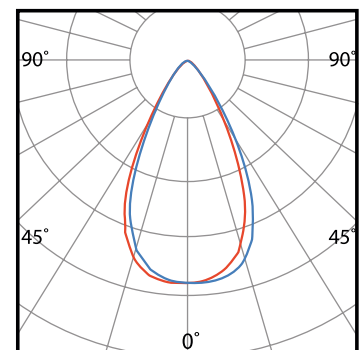

cd/klm — C0 - C180 — C90 - C270

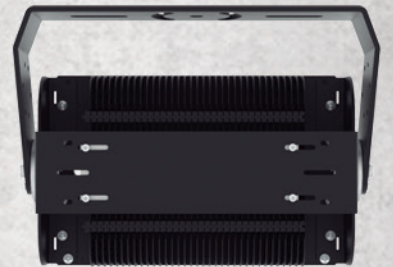



# LPK



## CARACTERÍSTICAS

POTENCIAS	45W, 90W
RANGO DE LÚMENES	5,000 y 9,400
IRC	≥70
PROTECCIÓN	IP65
VOLTAJE	120 - 277 V~
COLOR	5000 K
GARANTÍA	10 años

## DIMENSIONES

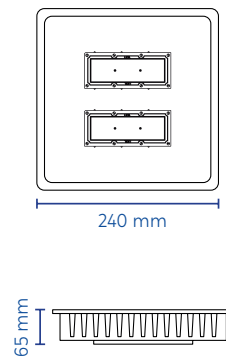

## ACCESORIOS

- Fococelda

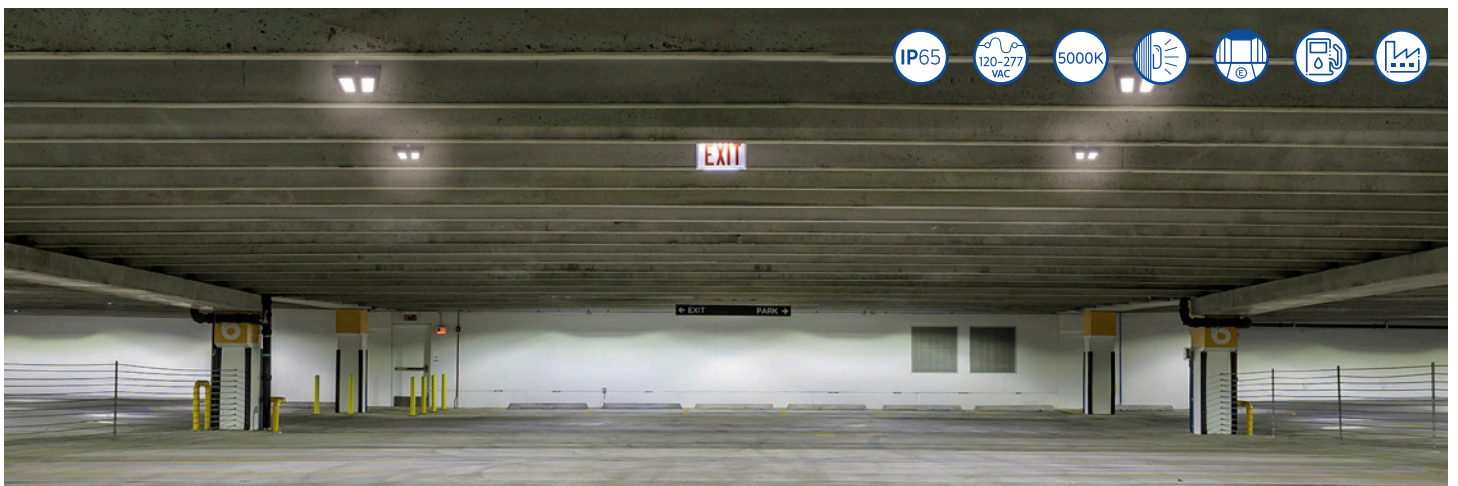

# GST



## CARACTERÍSTICAS

POTENCIAS	73W, 114W, 122W, 128W
RANGO DE LÚMENES	12,335 - 19,792
IRC	≥80
PROTECCIÓN	IP65
VOLTAJE	120 - 277 V~
COLOR	4000 y 5000 K
GARANTÍA	10 años

## DIMENSIONES

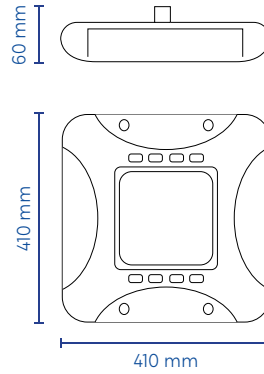

## INSTALACIÓN

· Para sobreponer



**HCX**

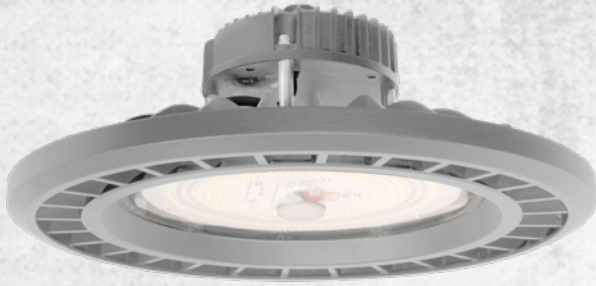

Luminaria LED tipo campana, diseñada para alto montaje. Su desempeño, alto rendimiento y excelente nivel de iluminación, posiciona este producto como una de las soluciones más efectivas para la iluminación industrial.



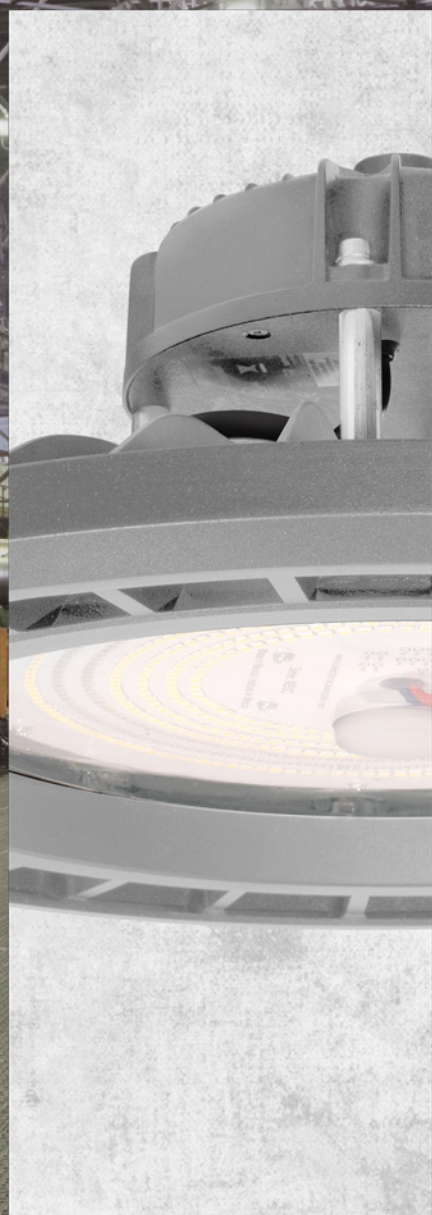
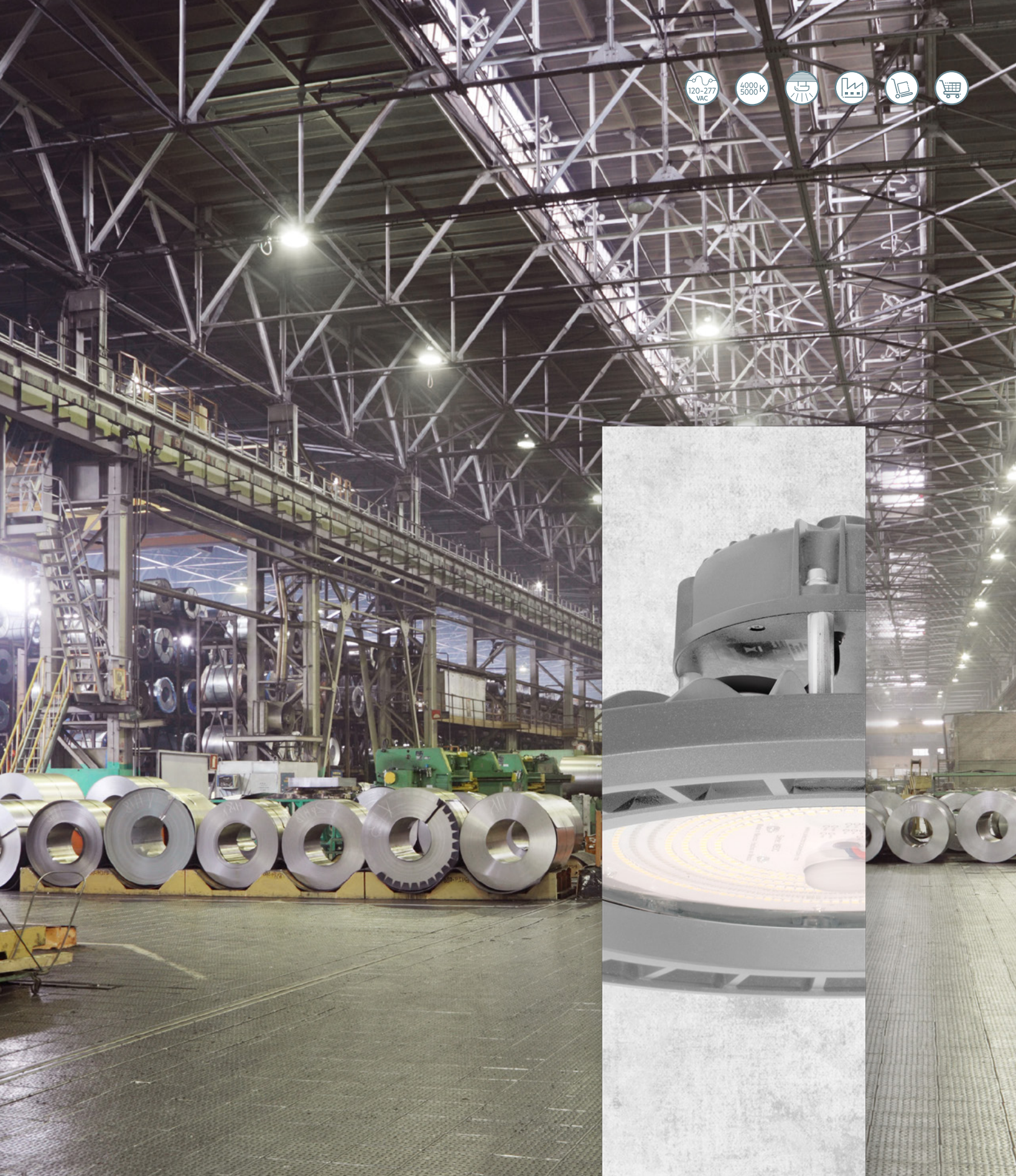

# HCX



## CARACTERÍSTICAS

POTENCIAS	85W - 248W
RANGO DE LÚMENES	12,300 - 40,200
IRC	≥80
PROTECCIÓN	IP65
VOLTAJE	120 - 277 V~
COLOR	4000 y 5000 K
GARANTÍA	10 años

## DIMENSIONES

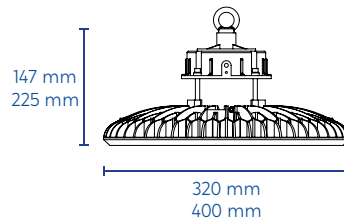

## ACCESORIOS

- Reflector de aluminio
- Automatización SupraLink
- Sensor de presencia

## TIPO DE CURVA

DISTRIBUCIÓN ABIERTA

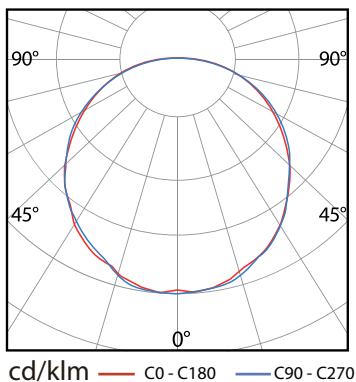

DISTRIBUCIÓN DIRIGIDA

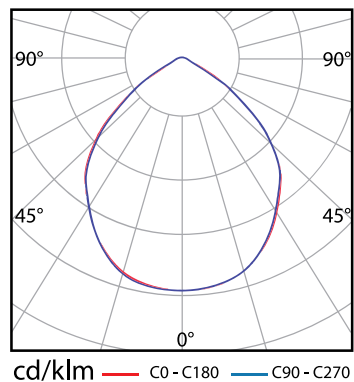

## COMPARATIVA DE RENDIMIENTO

FLUJO MANTENIDO AL 90% Y 70%

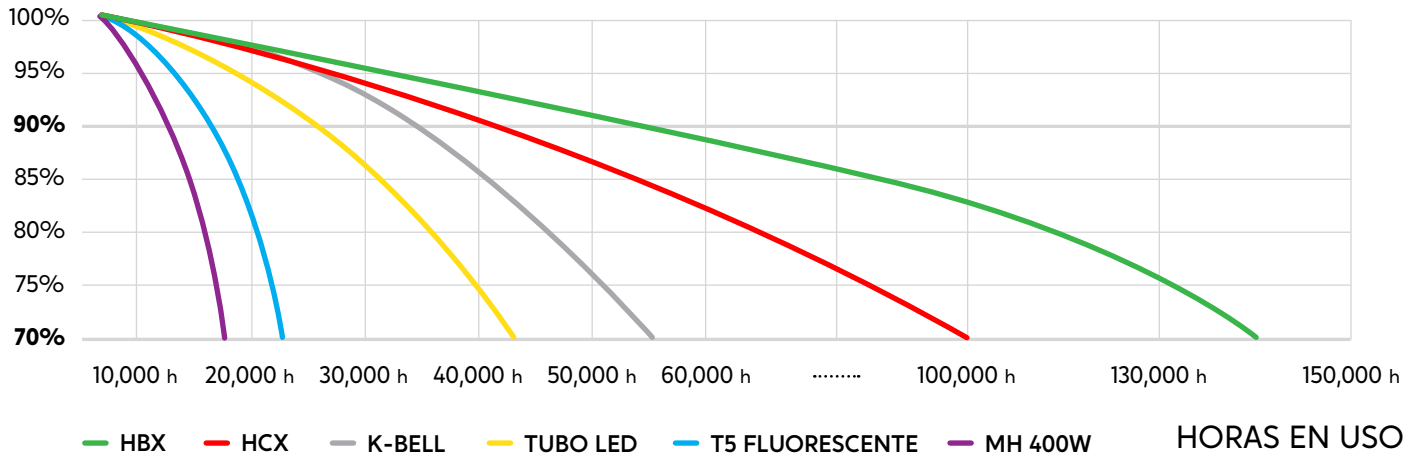

## REDUCE TU CONSUMO ELÉCTRICO

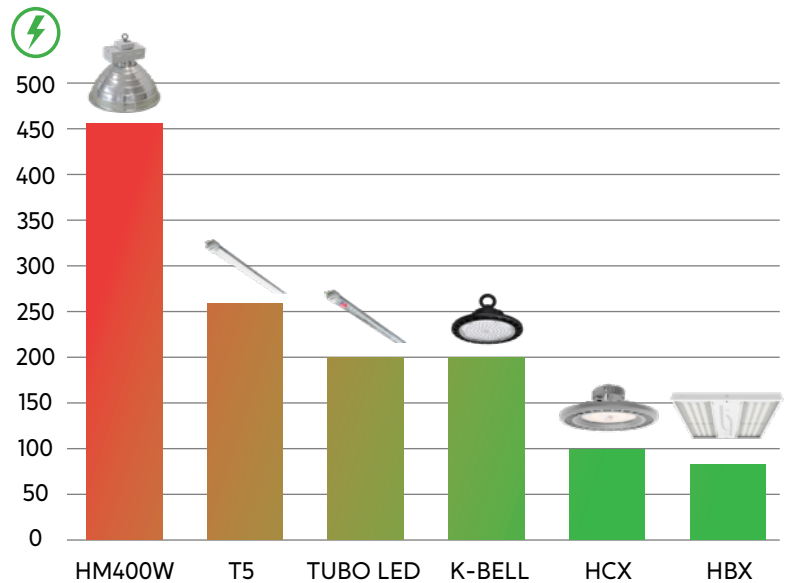

# HBX



ALTA EFICIENCIA



## CARACTERÍSTICAS

POTENCIAS	64W, 81W, 95W, 102W, 123W, 139W, 154W, 168W, 206W, 262W, 313W
RANGO DE LÚMENES	12,430 - 59,850
IRC	≥80
PROTECCIÓN	IP40
VOLTAJE	120 - 277 V~
COLOR	4000 y 5000 K
GARANTÍA	10 años

## DIMENSIONES

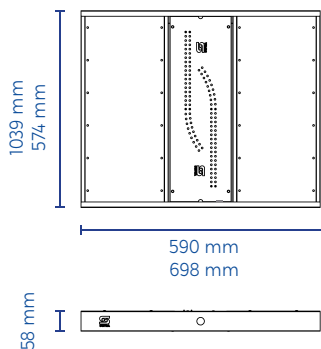

## ACCESORIOS

- Driver de emergencia
- Guarda protectora
- Difusor opalino
- Difusor transparente
- Reflectores de aluminio (fig. 1)
- Automatización SupraLink
- Sensor de presencia

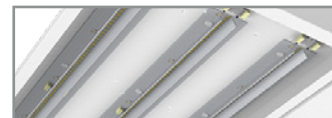
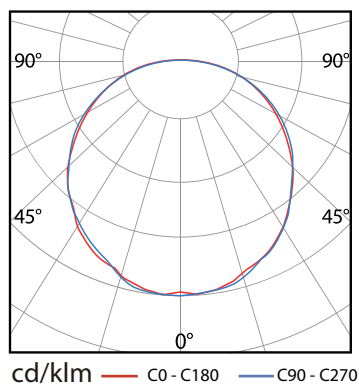

fig. 1

## TIPO DE CURVA

DISTRIBUCIÓN ABIERTA



DISTRIBUCIÓN DIRIGIDA

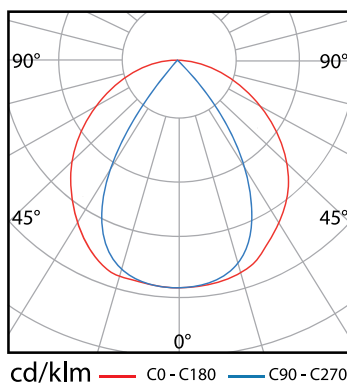



**EFICIENCIA DE  
200 lm/W**





## HBL-G2



La solución perfecta en iluminación para alto montaje. Fabricado con lámina de acero de primera calidad, con ventilación en todo el cuerpo para una disipación eficiente del calor, recubierto con pintura reflectante eficaz contra el deterioro. Además sus uniones electrosoldadas garantizan un producto sólido de larga vida útil.





# HBL-G2



## CARACTERÍSTICAS

POTENCIAS	84W, 109W, 121W, 133W, 150W, 173W, 219W
RANGO DE LÚMENES	13,300 - 38,500
IRC	≥70
PROTECCIÓN	IP40
VOLTAJE	120 - 277 V~
COLOR	4000 y 5000 K
GARANTÍA	10 años

## DIMENSIONES

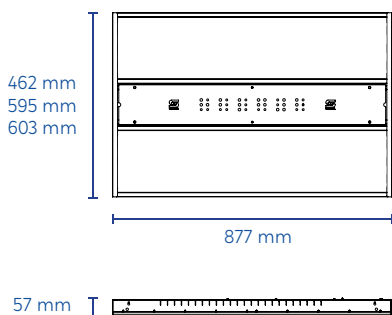

## ACCESORIOS

- Driver de emergencia
- Guarda protectora
- Difusor opalino
- Difusor transparente
- Reflectores de aluminio
- Automatización SupraLink
- Sensor de presencia

## TIPO DE CURVA

Distribución Abierta

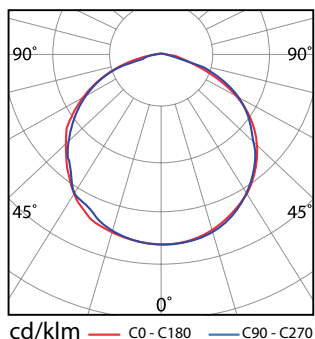

Distribución Dirigida

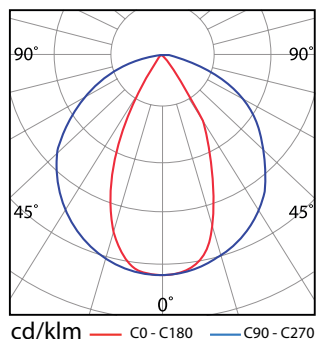

Distribución Dirigida con cubierta

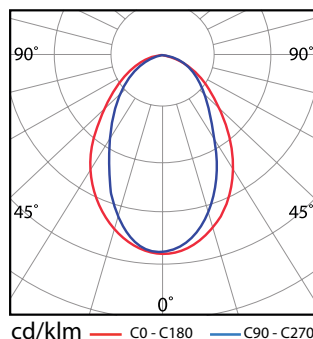

Distribución Abierta con cubierta

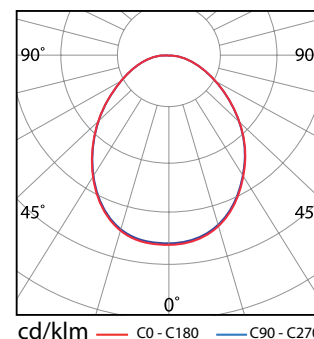

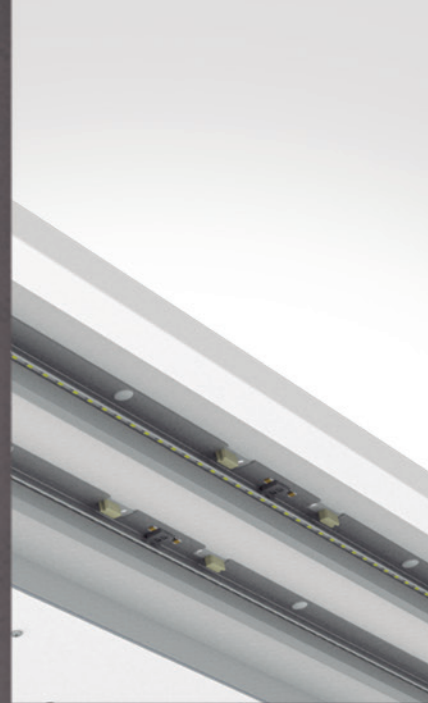

**ALTA EFICIENCIA  
EN TODAS SUS  
VARIANTES**



## HBL-G4



### CARACTERÍSTICAS

POTENCIAS	103W, 136W, 156W, 206W, 272W, 312W
RANGO DE LÚMENES	13,500 - 45,600
IRC	≥80
PROTECCIÓN	IP40
VOLTAJE	120 - 277 V~
COLOR	4000 y 5000 K
GARANTÍA	7 años

### DIMENSIONES

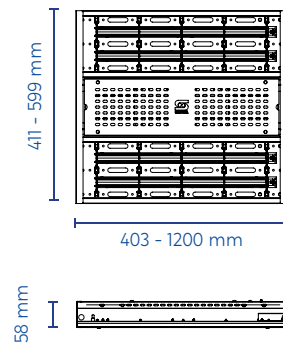

### ACCESORIOS

- Driver de emergencia
- Guarda protectora
- Difusor opalina
- Difusor transparente
- Reflectores de aluminio
- Automatización SupraLink
- Sensor de presencia

### TIPO DE CURVA

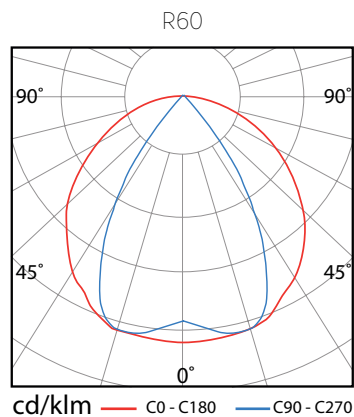
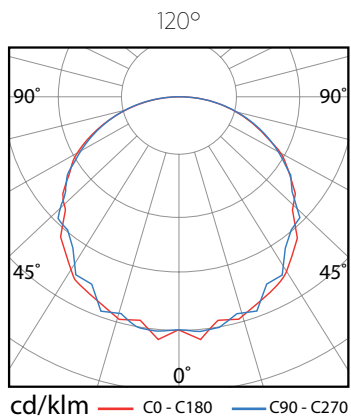

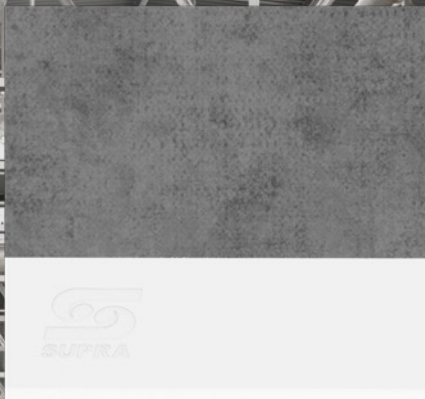

# HBL-G6



## CARACTERÍSTICAS

POTENCIAS	80W, 100W, 140W, 160W, 180W, 200W, 240W y 260W
RANGO DE LÚMENES	11,700 - 43,500
IRC	≥70
PROTECCIÓN	IP40
VOLTAJE	120 - 277 V~
COLOR	4000 y 5000 K
GARANTÍA	10 años

## DIMENSIONES

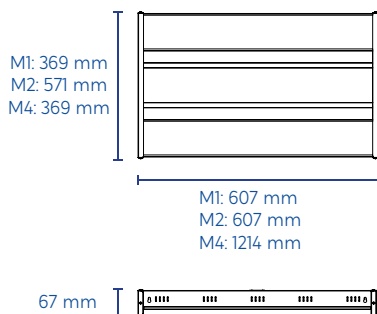

## ACCESORIOS

- Driver de emergencia
- Difusor opalino
- Reflectores de aluminio
- Automatización SupraLink
- Sensor de presencia

## TIPO DE CURVA

Distribución Abierta

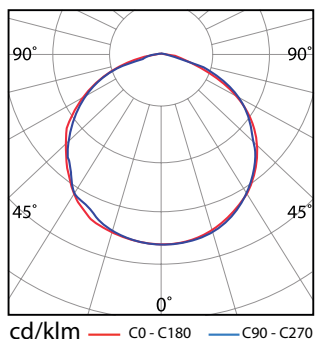

Distribución Dirigida

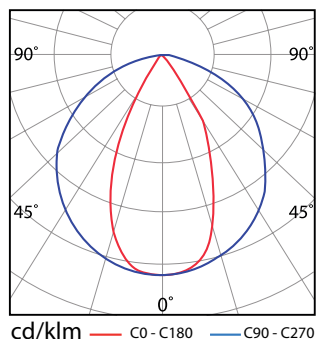

Distribución Dirigida con cubierta

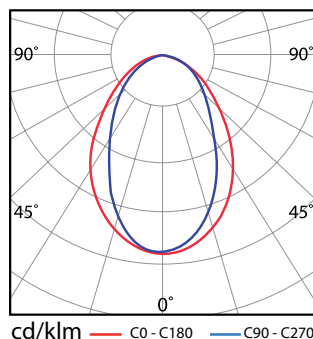

Distribución Abierta con cubierta

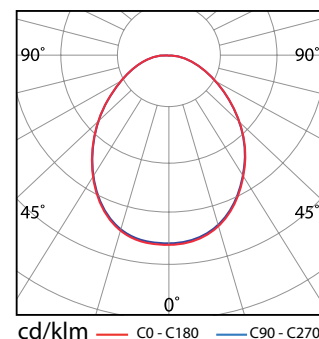



8 8

6 6

4 4

AS-IS  
CHECK  
HOME  
DELIV  
EXIT

↑  
Aisle  
40

Heavy load?  
Use carts for all heavy  
loads. Do not stack  
too heavy!

MALM  
\$199

HEMNES  
\$499



Find and order  
products here



# HLX



## CARACTERÍSTICAS

POTENCIAS	27W, 42W, 54W, 60W, 53W, 80W, 104W, 119W
RANGO DE LÚMENES	4,500 - 20,500
IRC	≥70
PROTECCIÓN	IP40
VOLTAJE	120 - 277 V~
COLOR	4000 y 5000 K
GARANTÍA	10 años

## DIMENSIONES

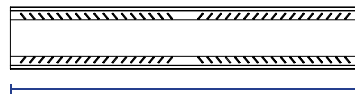

M4: 1145 mm  
M8: 2288 mm

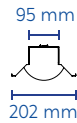

## ACCESORIOS

- Driver de emergencia
- Guarda protectora
- Difusor opalino
- Automatización SupraLink
- Sensor de presencia

## TIPO DE CURVA

Distribución Abierta

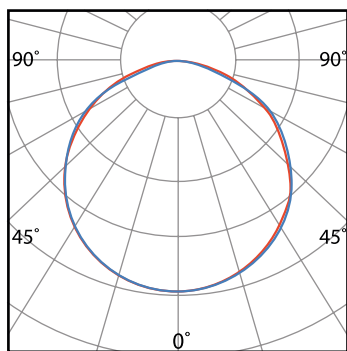

cd/klm — C0 - C180 — C90 - C270

Distribución Abierta con difusor

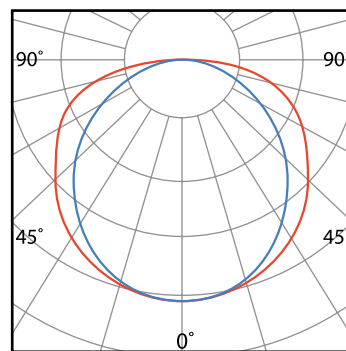

cd/klm — C0 - C180 — C90 - C270

Distribución Dirigida

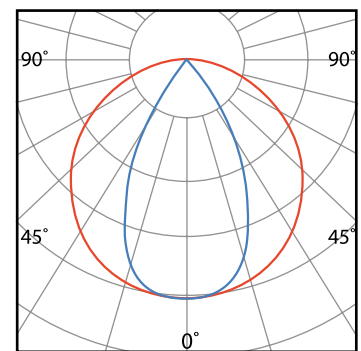

cd/klm — C0 - C180 — C90 - C270



\$24.90

\$25.90

MANGO HADEN  
\$19.90

## HB5



Difusor opalino



Difusor mate



### CARACTERÍSTICAS

POTENCIAS	74W - 379 W
RANGO DE LÚMENES	10,645 - 69,315
IRC	≥80
PROTECCIÓN	IP40
VOLTAJE	120 - 277 V~
COLOR	4000 y 5000 K
GARANTÍA	7 años

### DIMENSIONES

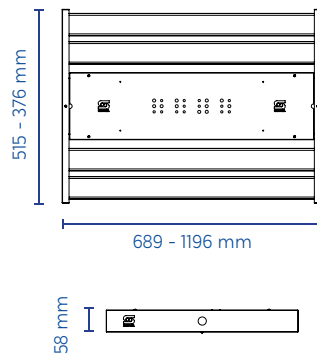

### ACCESORIOS

- Driver de emergencia
- Difusor opalino
- Automatización SupraLink
- Sensor de presencia

### TIPO DE CURVA

Distribución Abierta

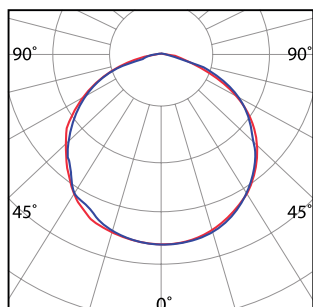

cd/klm — C0 - C180 — C90 - C270

Distribución Dirigida

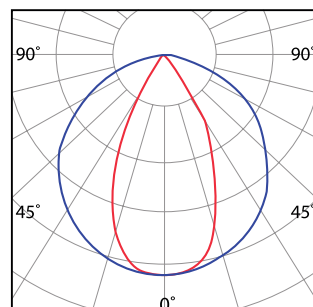

cd/klm — C0 - C180 — C90 - C270

Distribución Dirigida con cubierta

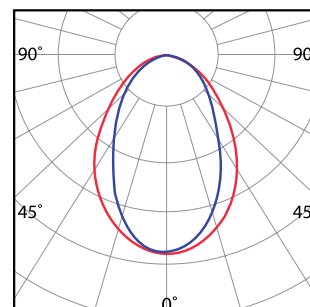

cd/klm — C0 - C180 — C90 - C270

Distribución Abierta con cubierta

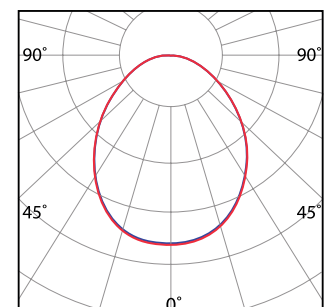

cd/klm — C0 - C180 — C90 - C270



## PV900



Diseñada con un alto nivel de sellado para evitar el ingreso de partículas de polvo y resistir chorros de agua ocasionales, es ideal para instalar en ambientes controlados.





IP65

120-277  
VAC

5000K



# PV900



## CARACTERÍSTICAS

POTENCIAS	62W, 81W, 102W, 124W
RANGO DE LÚMENES	9,200 - 18,400
IRC	≥70
PROTECCIÓN	IP65
VOLTAJE	120 - 277 V~
COLOR	4000 y 5000 K
GARANTÍA	7 años

## DIMENSIONES

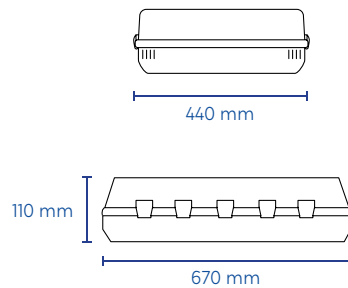

## ACCESORIOS

- Driver de emergencia
- Automatización SupraLink
- Sensor de presencia

## TIPO DE CURVA

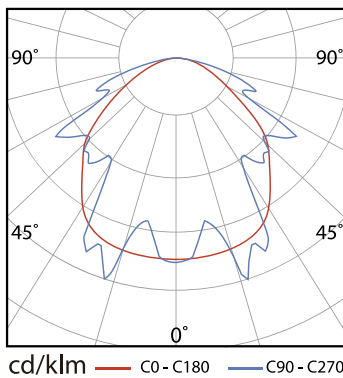

# PV400

**NOM**

## CARACTERÍSTICAS

POTENCIAS	142W, 172W, 197W, 219W
RANGO DE LÚMENES	22,200 - 33,300
IRC	≥70
PROTECCIÓN	IP65
VOLTAJE	120 - 277 V~
COLOR	4000 y 5000 K
GARANTÍA	7 años

## DIMENSIONES

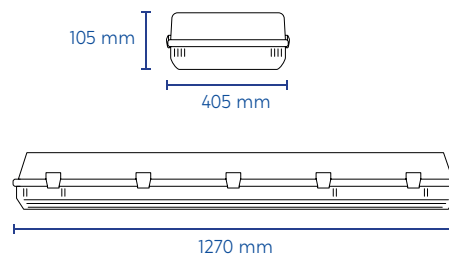

## ACCESORIOS

- Driver de emergencia
- Automatización SupraLink
- Sensor de presencia

## TIPO DE CURVA

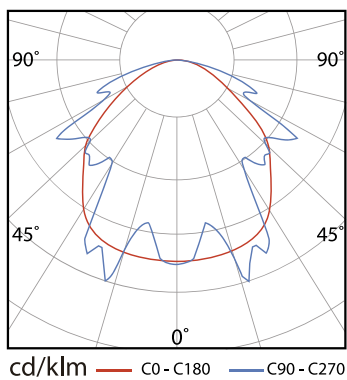



# PV200L

**NOM**

## CARACTERÍSTICAS

POTENCIAS	14W, 18W, 27W, 36W, 48W, 60W
RANGO DE LÚMENES	1,918 - 8,520
IRC	≥80
PROTECCIÓN	IP65
VOLTAJE	120 - 277 V~
COLOR	5000 K
GARANTÍA	7 años

## DIMENSIONES

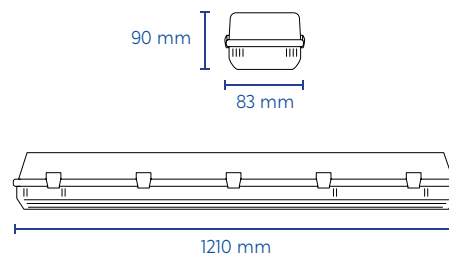

## ACCESORIOS

- Driver de emergencia
- Automatización SuprLink
- Sensor de presencia

## TIPO DE CURVA

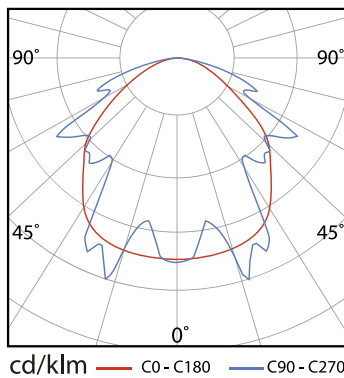

IP65

120-277  
VAC

5000K



## PV-XT



### CARACTERÍSTICAS

POTENCIAS	43W, 85W, 135W, 180W, 270W, 360W
RANGO DE LÚMENES	4,700 - 40,250
IRC	≥70
PROTECCIÓN	IP67
VOLTAJE	120 - 277 V~
COLOR	5000 K
GARANTÍA	7 años

### DIMENSIONES

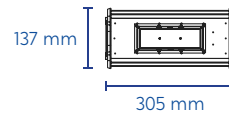

Ejemplo modelo de 43W

### ACCESORIOS

- Driver de emergencia
- Automatización SupraLink
- Sensor de presencia

### TIPO DE CURVA

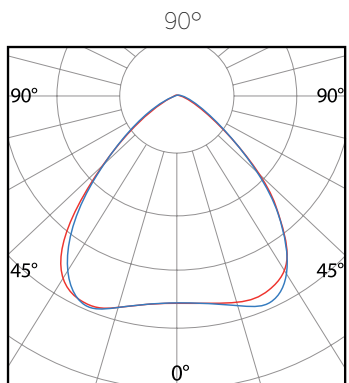

cd/klm — C0 - C180 — C90 - C270

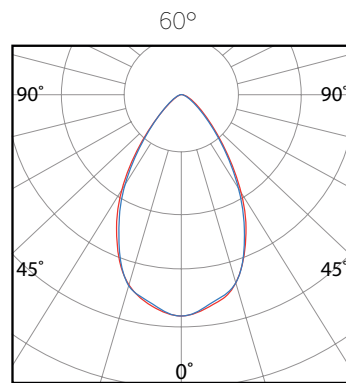

cd/klm — C0 - C180 — C90 - C270

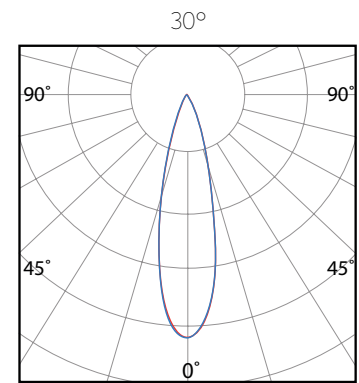

cd/klm — C0 - C180 — C90 - C270

IP67

120-277  
VAC

5000K



ALTO GRADO DE  
PROTECCIÓN  
IP67

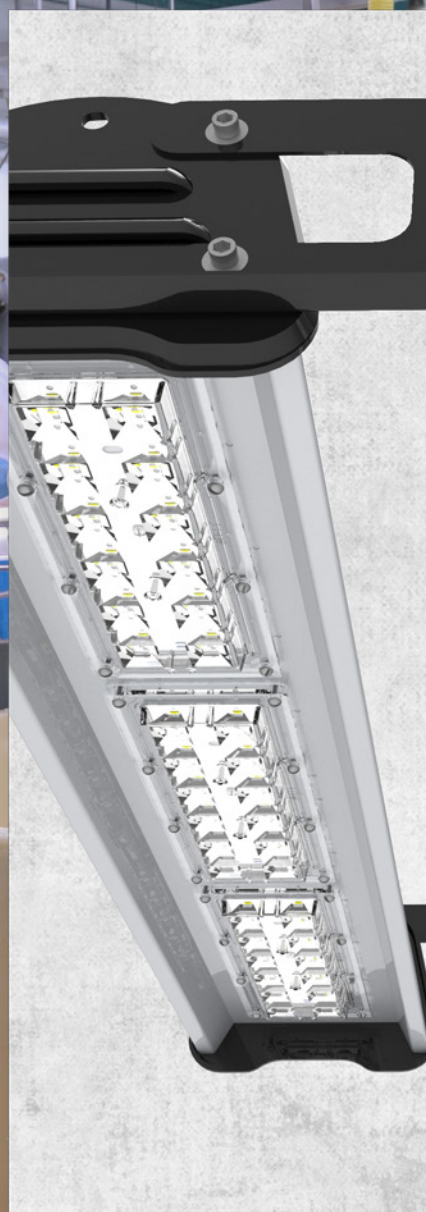

# SLSF



## CARACTERÍSTICAS

POTENCIAS	19W, 29W, 39W, 49W, 79W y 99W
RANGO DE LÚMENES	2,770 - 13,640
IRC	≥70
PROTECCIÓN	IP67
VOLTAJE	120 - 277 V~
COLOR	5000 K
GARANTÍA	7 años

## DIMENSIONES

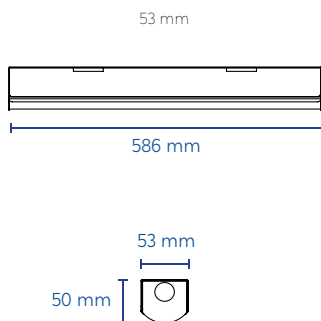

## ACCESORIOS

- Driver de emergencia
- Automatización SupraLink
- Kit para suspender

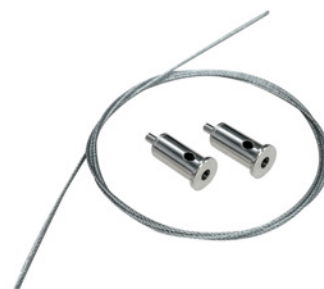

## TIPO DE CURVA

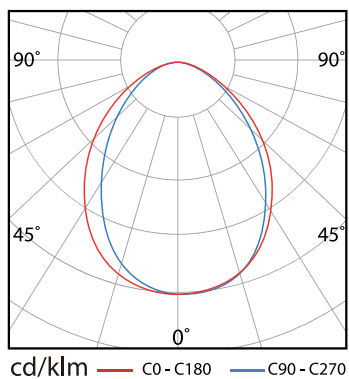





# SCL-191

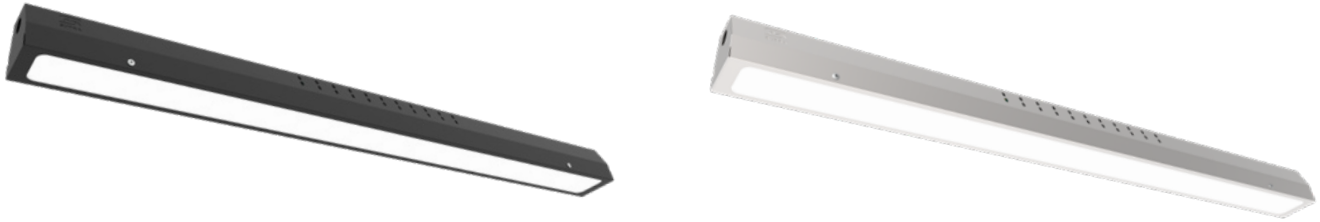

## CARACTERÍSTICAS

POTENCIAS	9W, 14W, 18W, 29W, 37W, 58W, 65W, 75W, 131W
RANGO DE LÚMENES	1,000 - 14,400
IRC	≥80
PROTECCIÓN	IP50
VOLTAJE	120 - 277 V~
COLOR	4000 y 5000 K
GARANTÍA	7 años

## DIMENSIONES

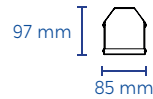

M2: 610 mm  
M4: 1220 mm  
M8: 2440 mm

## ACCESORIOS

- Driver de emergencia
- Automatización SupraLink
- Sensor de presencia

## TIPO DE CURVA

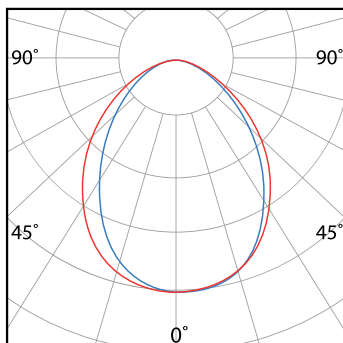

cd/klm — C0 - C180 — C90 - C270

## OPCIONES DE INSTALACIÓN

SOBREPONER

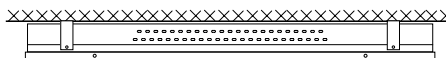

SUSPENDIDA

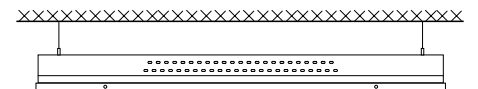

# LIN



## CARACTERÍSTICAS

POTENCIAS	16W, 22W, 29W, 32W, 44W, 58W
RANGO DE LÚMENES	2,400 - 9,100
IRC	≥80
PROTECCIÓN	IP50
VOLTAJE	120 - 277 V~
COLOR	4000 y 5000 K
GARANTÍA	7 años

## DIMENSIONES

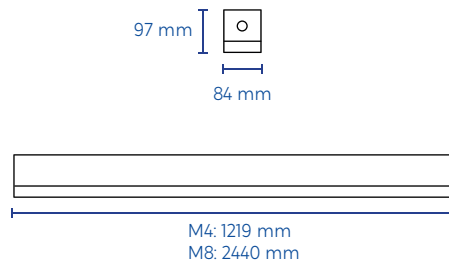

## ACCESORIOS

- Difusor opalino
- Driver de emergencia
- Automatización SupraLink
- Sensor de presencia



## ADITAMENTO TANDEM

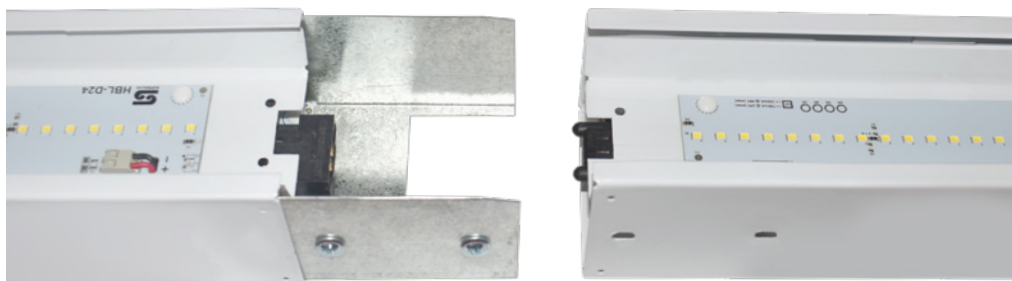



# SLL-114



cuentan con mica cristal policarbonato

## CARACTERÍSTICAS

POTENCIAS	23W, 31W, 42W, 47W, 58W, 72W, 88W, 95W
RANGO DE LÚMENES	3,000 - 16,500
IRC	≥80
PROTECCIÓN	IP64*
VOLTAJE	120 - 277 V~
COLOR	5000 K
GARANTÍA	7 años

## DIMENSIONES

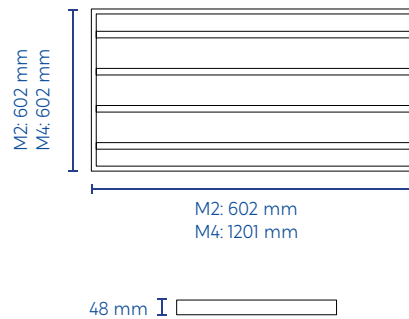

## ACCESORIOS

- Driver de emergencia
- Automatización SupraLink
- Sensor de presencia

\* Grado de protección en módulos LED

## TIPO DE CURVA

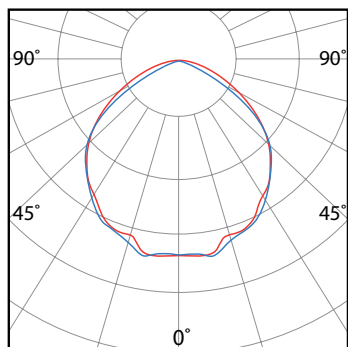

cd/klm — C0 - C180 — C90 - C270

IP50

120-277  
VAC

5000K



## VAP



SERIE: VAPW



SERIE: VAPT



### MATERIAL

Fabricados en inyección de aluminio, acabado con pintura poliéster color gris. Esta sellada con empaques especiales que protegen sus componentes en ambientes húmedos.

- IP65

### CARACTERÍSTICAS

- Caja de conexiones de 4 pulgadas, conducto de 3/4"
- Adaptable para bombilla incandescente de hasta 150W
- Apto para focos LED y fluorescentes.
- Globo de vidrio transparente
- Enchufe E26.
- Adecuado para ambientes húmedos listado.

### INSTALACIÓN

Diseñado para instalación de sobreponer con tapa.



### DIMENSIONES

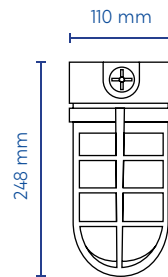
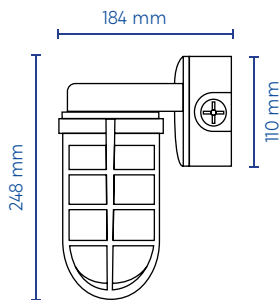



## CAL



Luminaria LED con alto grado de protección, combina rendimiento óptico, eficiencia energética con una resistencia excepcional a las altas temperaturas, soporta hasta 80°C, lo que la hace ideal para instalar en ambientes extremos.





IP67

120-277  
VAC

5000K



**ALTA  
RESISTENCIA  
AL CALOR**



# CAL



## CARACTERÍSTICAS

POTENCIAS	150W
RANGO DE LÚMENES	22,500
IRC	≥70
PROTECCIÓN	IP67
VOLTAJE	120 - 277 V~
COLOR	5000 K
GARANTÍA	5 años

## DIMENSIONES

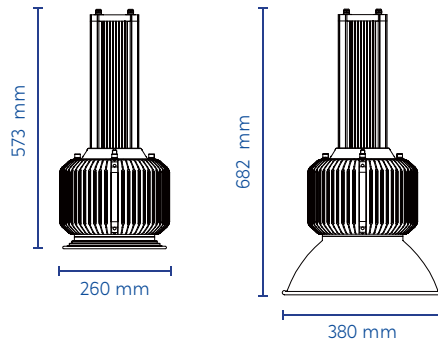

## ACCESORIOS

- Reflector de aluminio (fig. 1)
- Driver de emergencia
- Automatización SupraLink
- Sensor de presencia



fig.1

## OPCIONES DE SUJECIÓN



ANILLO



GANCHO



CAJA



NPT 3/4"



BRACKET



## LUMINARIAS PARA ÁREAS CLASIFICADAS

Se considera área clasificada a todas aquellas locaciones en donde se producen o contienen vapores, líquidos y/o gases inflamables, polvos y fibras combustibles, que pueden causar fuego o explosiones si se someten a una fuente de ignición.

Una luminaria diseñada a prueba de explosión esta construida especialmente para resistir una explosión en su interior sin alterar o modificar sus características de construcción, evitando totalmente la transmisión de chispas o fuego hacia el ambiente exterior. Esto permite que los gases producto de una explosión interna sean enfriados, y posteriormente desalojados con una temperatura que no provoque una explosión externa.

### CLASES

Definen la explosividad o combustibilidad de las sustancias presentes en la atmósfera.

**CLASE I** Lugares donde hay presentes gases, vapores y líquidos inflamables.

**CLASE II** Lugares con presencia de polvos inflamables.

**CLASE III** Lugares que son peligrosos por la presencia de fibras o materiales volátiles fácilmente inflamables.

### DIVISIONES

Definen el grado de peligro dada la concentración de explosivos o sustancias combustibles en la atmósfera.

**DIVISIÓN 1** Elementos presentes de forma PERMANENTE o CONSTANTE en el ambiente.

**DIVISIÓN 2** Elementos presentes de forma TEMPORAL o MOMENTÁNEA en el ambiente.



## PEL-A



Luminaria a prueba de explosión, diseñada para ambientes peligrosos como la industria petroquímica, entre otras áreas, donde se requiera un grado de protección especial.





IP66

120-277  
VAC

5000K



## PEL-A



### CARACTERÍSTICAS

POTENCIAS	60W, 80W, 100W, 150W
RANGO DE LÚMENES	5,400 - 20,250
IRC	≥70
PROTECCIÓN	IP66
VOLTAJE	120 - 277 V~
COLOR	5000 K
GARANTÍA	5 años

### DIMENSIONES

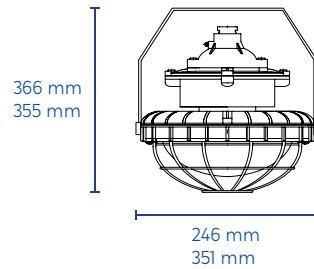

### CERTIFICACIONES

- CLASE I, DIV. 1&2, GRUPOS B, C, D
- CLASE I, ZONA 1&2, GPOS. IIB+H2, IIA
- CLASE II, DIV. 1&2, GRUPOS EFG
- CLASE III
- CAJA TIPO 4 (NEMA 4, 7B CD, 9EFG)

### ACCESORIOS

- Guarda protectora

### TIPO DE CURVA

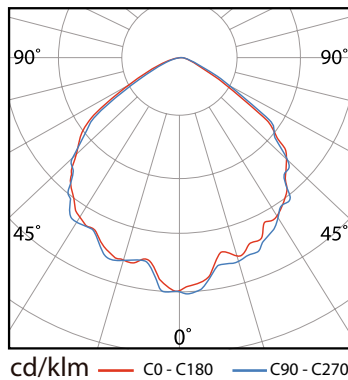

### OPCIONES DE SUJECIÓN

SOBREPONER CON BRACKET EN TECHO, PARED O PISO

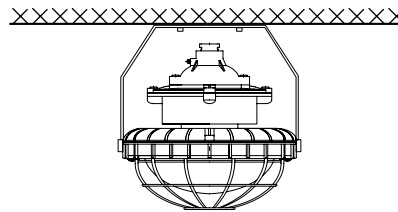

SUSPENDER CON TUBO ROSCADO

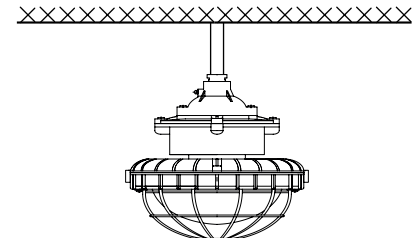

# PEL-B



## CARACTERÍSTICAS

POTENCIAS	20W, 40W, 50W, 60W, 80W, 100W, 120W, 150W
RANGO DE LÚMENES	1,970 - 14,500
IRC	≥70
PROTECCIÓN	IP66
VOLTAJE	120 - 277 V~
COLOR	4000 K y 5000 K
GARANTÍA	5 años

## DIMENSIONES

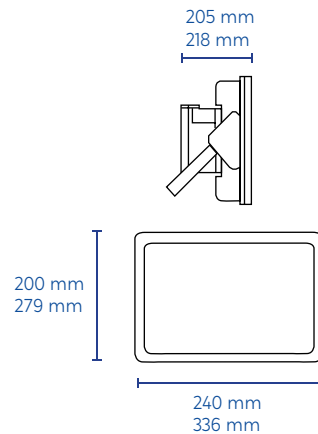

## CERTIFICACIONES

- CLASE I, DIV. 1&2, GRUPOS B, C, D
- CLASE I, ZONA 1&2, GPOS. IIB+H2, IIA
- CLASE II, DIV. 1&2, GRUPOS EFG
- CLASE III
- CAJA TIPO 4 (NEMA 4, 7B CD, 9EFG)



## PEL-C



### CARACTERÍSTICAS

POTENCIAS	80W, 100W y 150W
RANGO DE LÚMENES	10,400 - 19,500
IRC	≥70
PROTECCIÓN	IP65
VOLTAJE	120 - 277 V~
COLOR	3000 K, 4000 K y 5000 K
GARANTÍA	5 años

### DIMENSIONES

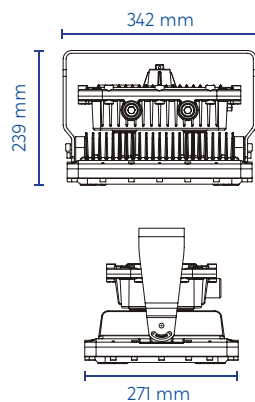

### CONFORMIDAD

- CLASE I DIVISIÓN 1, GRUPO C, D
- CLASE I DIVISIÓN 2, GRUPO A, B, C, D
- CLASE II DIVISIÓN 2, GRUPO F, G
- CLASE III
- CLASE I, ZONA 1, GRUPO IIB
- CLASE I, ZONA 2, GRUPO IIC

### OPCIONES DE SUJECIÓN



COLGANTE

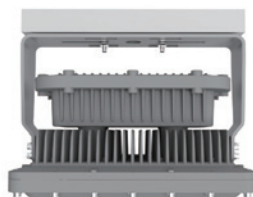

ATORNILLADA A TECHO O PARED



PUNTA DE POSTE

## PEL-E

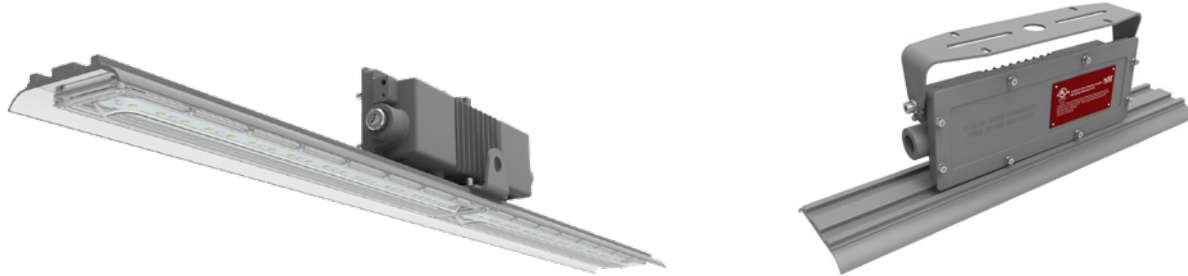

### CARACTERÍSTICAS

POTENCIAS	40W y 80W
RANGO DE LÚMENES	5,480 y 10,950
IRC	≥70
PROTECCIÓN	IP65
VOLTAJE	120 - 277 V~
COLOR	5000 K
GARANTÍA	5 años

### DIMENSIONES

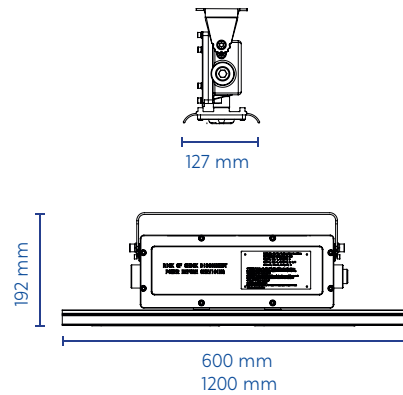

### CERTIFICACIONES

- CLASE I DIVISIÓN II, GRUPO A, B, C, D
- CLASE II, DIVISIÓN I, GRUPOS E, F, G
- CLASE III, DIVISIÓN I

### TIPO DE CURVA

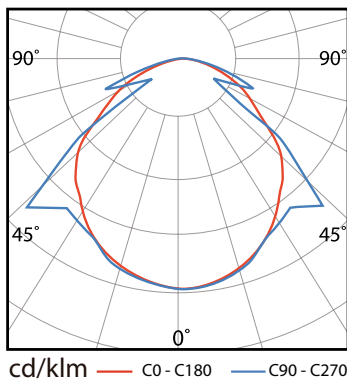

### OPCIONES DE SUJECIÓN

SOBREPONER CON BRACKET  
EN TECHO, PARED O PISO

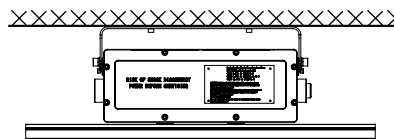

### ACCESORIOS

- Driver de emergencia

## PEL-G

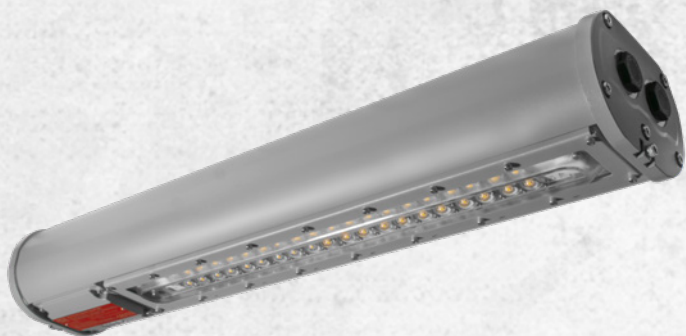

Luminaria a prueba de explosión, diseñada para ambientes peligrosos como la industria petroquímica, entre otras áreas, donde se requiera un grado de protección especial.





IP66

120-277  
VAC

5000K





# PEL-G

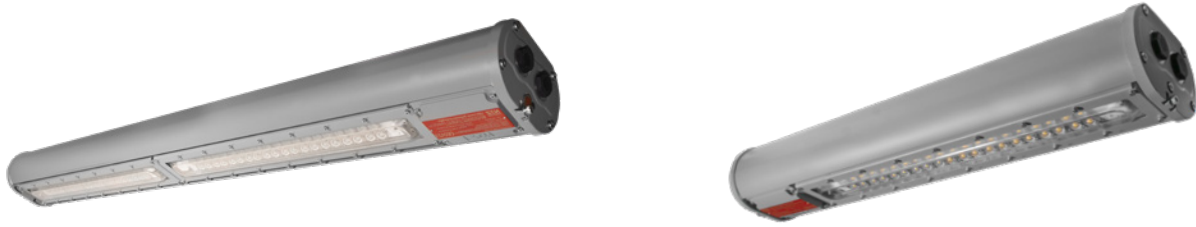

## CARACTERÍSTICAS

POTENCIAS	30W, 50W y 100W
RANGO DE LÚMENES	3,600 - 12,000
IRC	≥70
PROTECCIÓN	IP66 / IK10 / 5G
VOLTAJE	120 - 277 V~
COLOR	5000 K
GARANTÍA	5 años

## DIMENSIONES

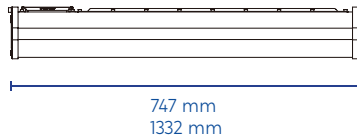
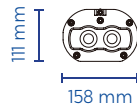

## CERTIFICACIONES

- CLASE I DIVISIÓN I
- ZONA 1, 21

PARA GASES Y VAPORES

## TIPO DE CURVA

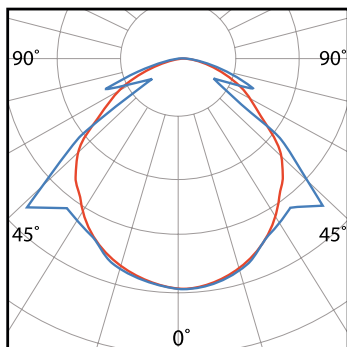

cd/klm — C0 - C180 — C90 - C270

## OPCIONES DE SUJECIÓN

EN AMBOS EXTREMOS DE LA CONEXIÓN

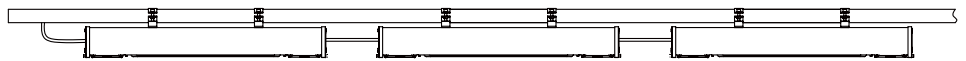

EN EL EXTREMO DEL CABLE

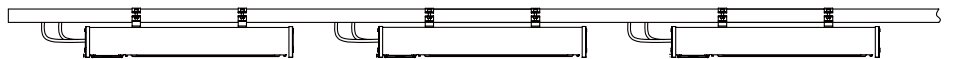

# PEL-G

## OPCIONES DE SUJECIÓN

SUJECIÓN DE BAJO MONTAJE EN TECHO



SOPORTE DE ALTO MONTAJE EN TECHO



AROS DE MONTAJE PARA TECHO

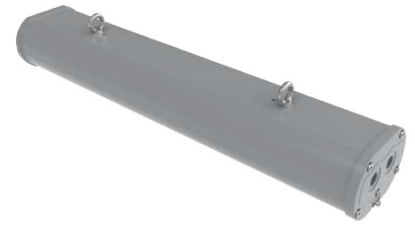

SOPORTE GIRATORIO PARA MONTAR EN PARED

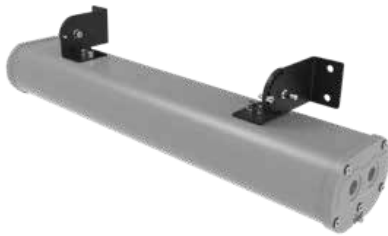

SOPORTE DE EXTENSIÓN PARA MONTAR EN PARED



ABRAZADERA PARA MONTAR EN POSTE

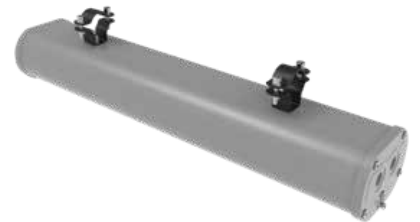

# PEL-I



## CARACTERÍSTICAS

POTENCIAS	40W y 80W
RANGO DE LÚMENES	4,800 y 9,600
IRC	≥70
PROTECCIÓN	IP66 / IK10 / 5G
VOLTAJE	120 - 277 V~
COLOR	5000 K
GARANTÍA	5 años

## DIMENSIONES

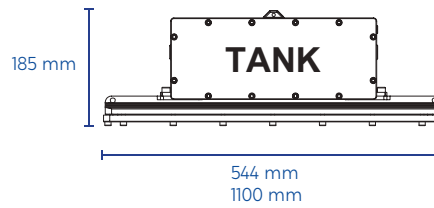

## CERTIFICACIONES

- CLASE I DIVISIÓN 1, GRUPO C, D
- CLASE I DIVISIÓN 2, GRUPO A, B, C, D
- CLASE I, ZONE 1, GRUPO IIB
- CLASE I, ZONE 2, GRUPO IIC



COLGANTE CON TUBO O CADENA



ATORNILLADA A TECHO O PARED



INSTALACIÓN EN POSTE

IP66

120-277  
VAC

5000K



## PEL-K

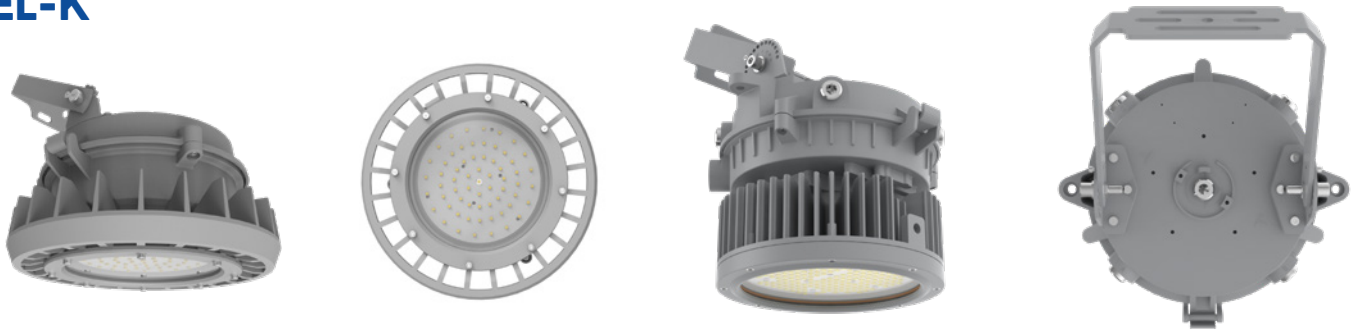

### CARACTERÍSTICAS

POTENCIAS	30W, 45W, 65W, 80W, 120W, 150W, 200W
RANGO DE LÚMENES	4,500 - 30,000
IRC	≥70
PROTECCIÓN	IP66 IK08
VOLTAJE	120 - 277 V~
COLOR	5000 K
GARANTÍA	5 años

### DIMENSIONES

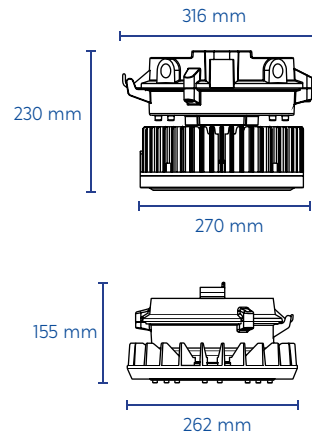

### CERTIFICACIONES

- CLASE I DIVISIÓN II, GRUPO A, B, C, D
- CLASE II, DIVISIÓN I, GRUPOS E,F,G
- CLASE II, DIVISIÓN I, GRUPOS F,G
- CLASE III, DIVISIÓN I

### ACCESORIOS

- Soporte de fijación de 90°
- Brazo de 90°
- Brazo de 25°
- Guarda protectora

### TIPO DE CURVA

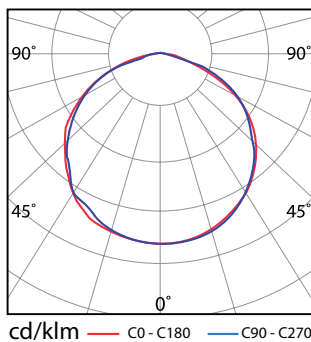

### MODELOS



30W, 45W, 65W, 80W



120W, 150W, 200W

# PEL-K

## OPCIONES DE SUJECIÓN

COLGANTE

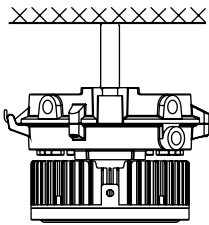

SOBREPONER

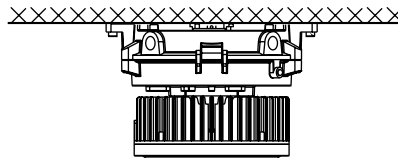

FIJACIÓN CON SOPORTE

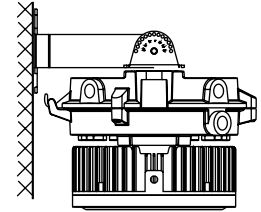

FIJACIÓN DE PARED

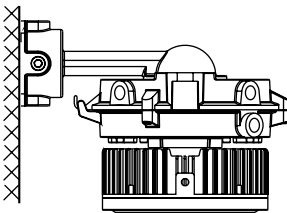

SOPORTE DE PUNTA 90°

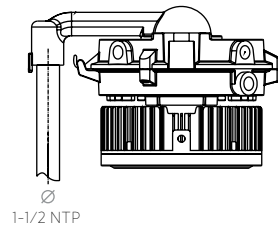

SOPORTE DE PUNTA 25°

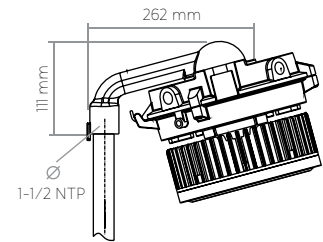

## SDL-380

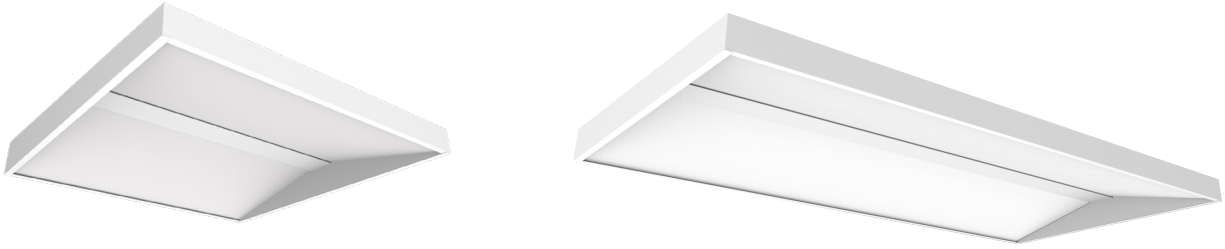

### CARACTERÍSTICAS

POTENCIAS	15W, 23W, 31W, 32W, 40W, 47W, 63W 80W
RANGO DE LÚMENES	2,000 - 10,300
IRC	≥80
PROTECCIÓN	IP40
VOLTAJE	120 - 277 V~
COLOR	4000 y 5000 K
GARANTÍA	10 años

### DIMENSIONES

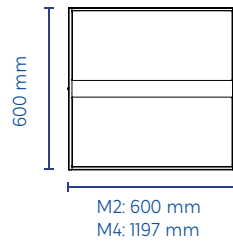

### ACCESORIOS

- Driver de emergencia
- Automatización SupraLink
- Sensor de presencia







## SDL-321

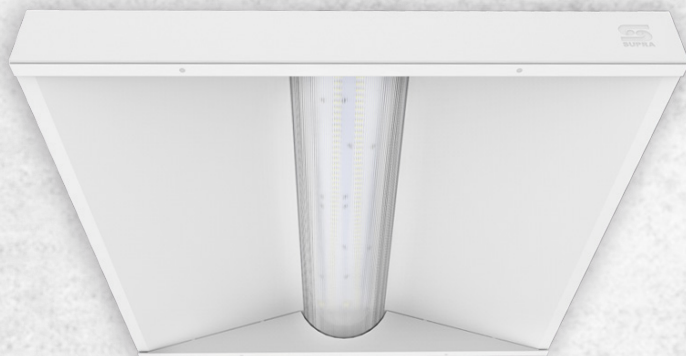

La combinación perfecta entre diseño estético y alta eficiencia de rendimiento. Brinda iluminación superior para alturas de medio y bajo montaje.





## SDL-321



### CARACTERÍSTICAS

POTENCIAS	20W, 30W, 45W, 63W, 83W
RANGO DE LÚMENES	2,600 - 11,100
IRC	≥80
PROTECCIÓN	IP40
VOLTAJE	120 - 277 V~
COLOR	3000, 4000 y 5000 K
GARANTÍA	10 años

### DIMENSIONES

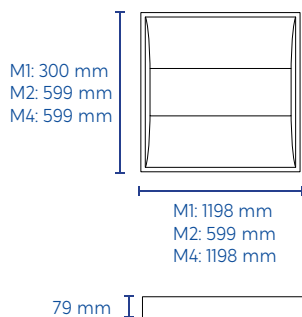

### ACCESORIOS

- Driver de emergencia
- Automatización SupraLink
- Sensor de presencia



SQR

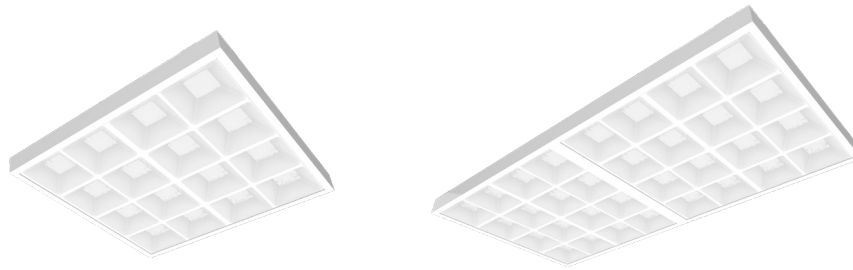

## CARACTERÍSTICAS

POTENCIAS	35W y 68W
RANGO DE LÚMENES	3,700 y 6,200
IRC	≥80
PROTECCIÓN	IP40
VOLTAJE	120 - 277 V~
COLOR	5000 K
GARANTÍA	7 años

## DIMENSIONES

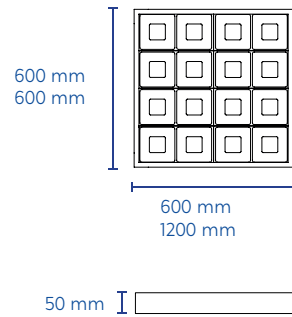

## ACCESORIOS

- Driver de emergencia
- Sensor de presencia

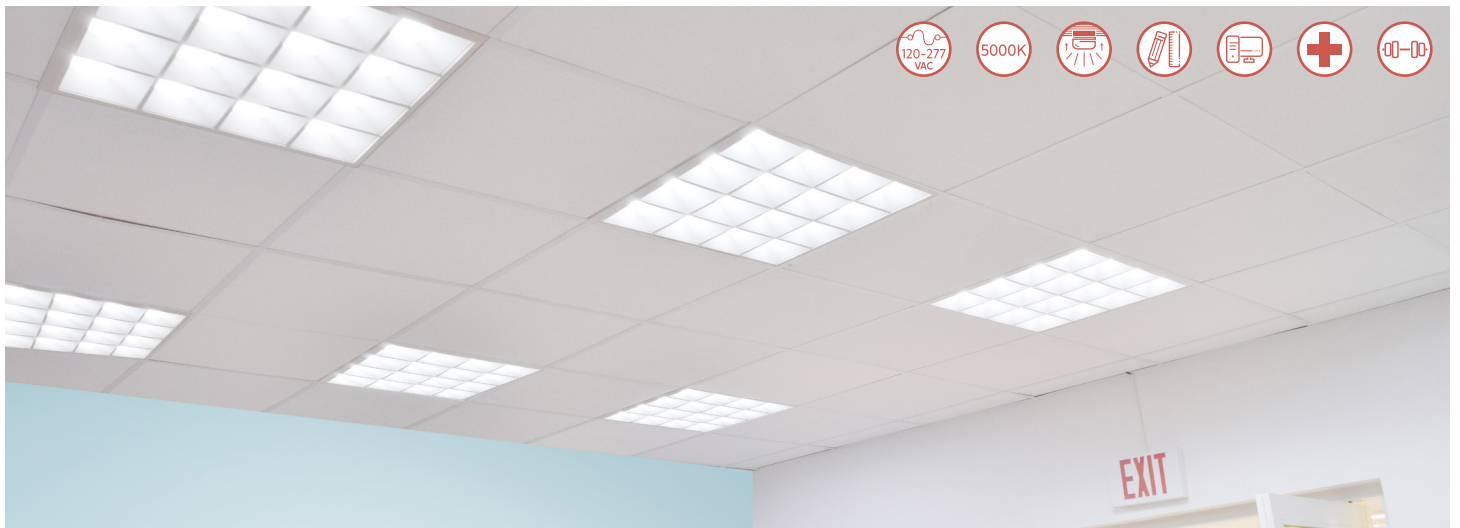

# MARCO

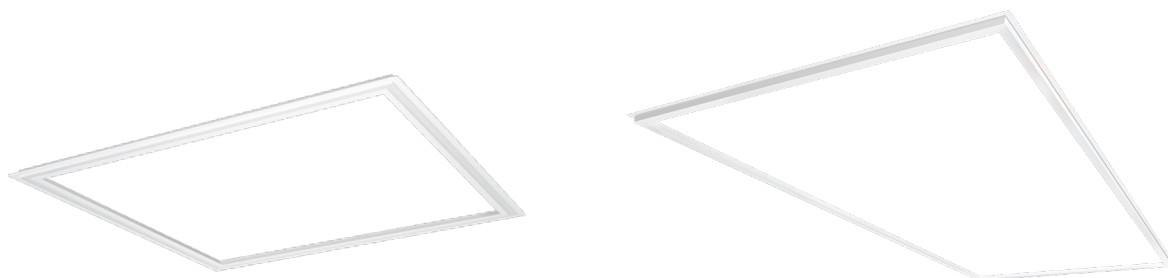

## CARACTERÍSTICAS

POTENCIAS	42W y 60W
RANGO DE LÚMENES	2,800 - 5,000
IRC	≥80
PROTECCIÓN	IP40
VOLTAJE	120 - 240 V~
COLOR	5000 K
GARANTÍA	7 años

## DIMENSIONES

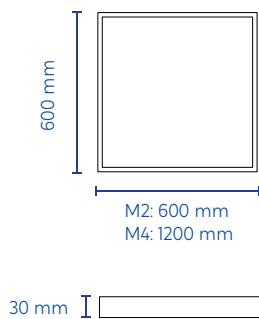

## ACCESORIOS

- Driver de emergencia

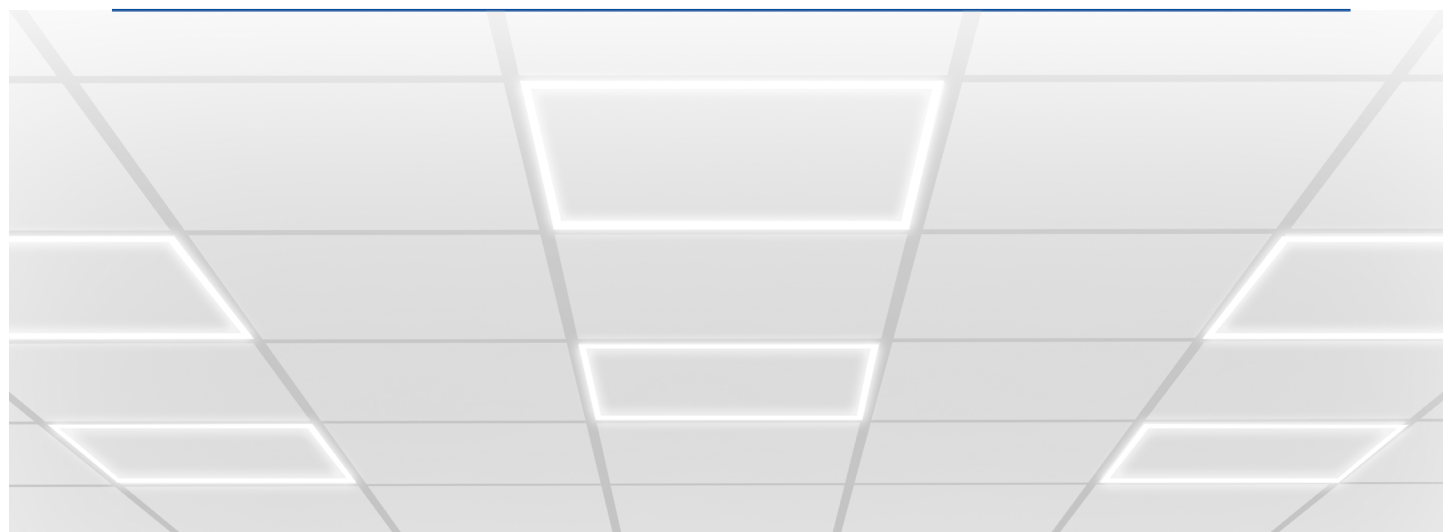



## PLED2

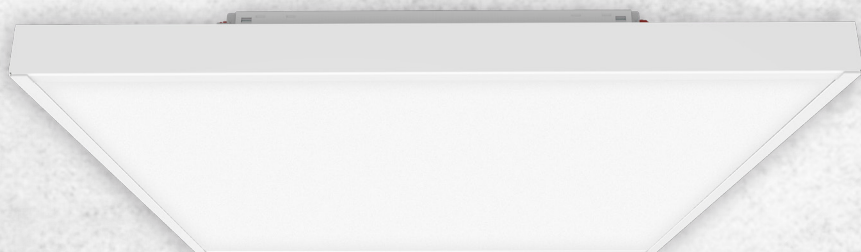

Luminaria panel LED, ilumina tus espacios con un panel que cubre toda el área de un plafón, brinda confort visual y una iluminación uniforme. Cuenta con placa de disipación en la parte posterior y mica opalina como sistema de difusión lumínica.





5000K





## PLED2



PLED2-M1



PLED2-M2



PLED2-M4

### CARACTERÍSTICAS

POTENCIAS	18W, 26W, 36W, 45W, 50W, 70W, 89W
RANGO DE LÚMENES	2,400 - 10,800
IRC	≥80
PROTECCIÓN	IP40
VOLTAJE	120 - 277 V~
COLOR	3000, 4000 y 5000 K
GARANTÍA	10 años

### DIMENSIONES

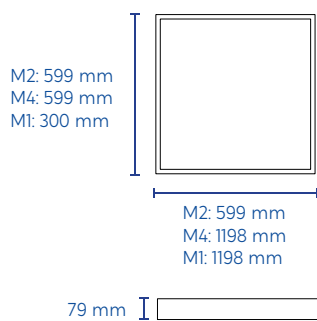

### ACCESORIOS

- Driver de emergencia
- Automatización SupraLink
- Sensor de presencia

### TIPO DE CURVA

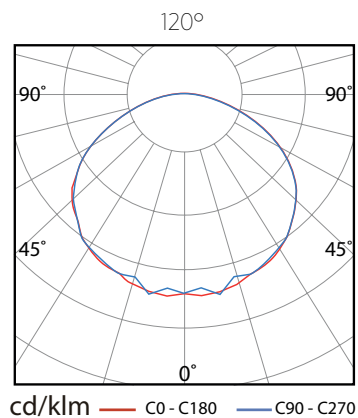

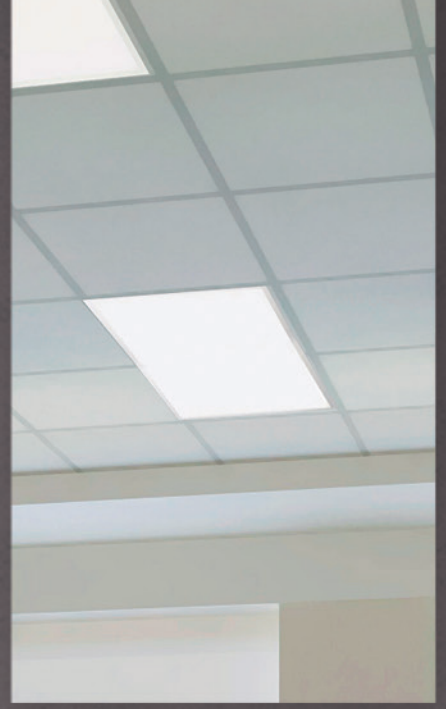
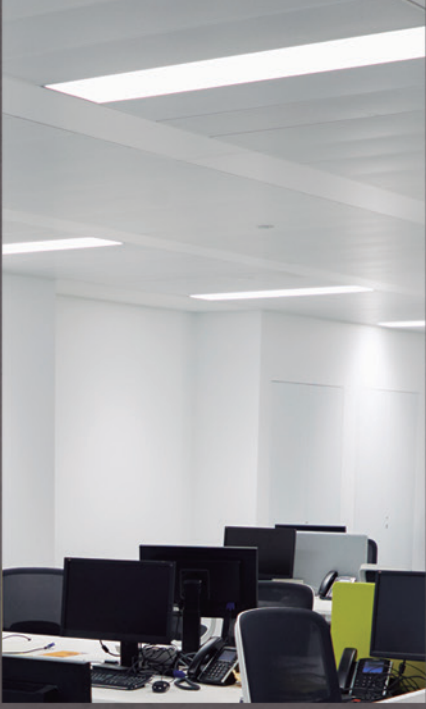

# SDQ



## CARACTERÍSTICAS

POTENCIAS	45W - 260W
RANGO DE LÚMENES	6,200 - 28,800
IRC	≥80
PROTECCIÓN	IP66
VOLTAJE	120 - 277 V~
COLOR	5000 K
GARANTÍA	10 años

## DIMENSIONES

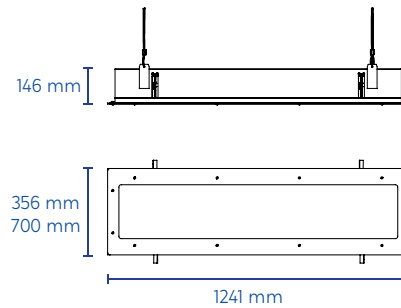

## ACCESORIOS

- Driver de emergencia
- Automatización SupraLink
- Sensor de presencia





# WRAP



## CARACTERÍSTICAS

POTENCIAS	19W, 22W, 35W, 47W
RANGO DE LÚMENES	2,670 - 6,370
IRC	≥80
VOLTAJE	120 - 277 V~
COLOR	4000 K y 5000 K
GARANTÍA	10 año

## DIMENSIONES

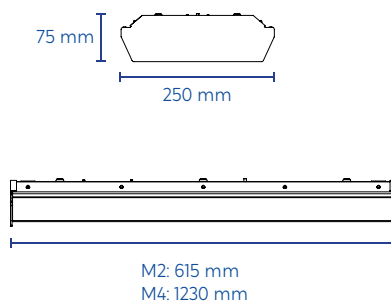

## ACCESORIOS

- Driver de emergencia
- Automatización SupraLink
- Sensor de presencia

## TIPO DE CURVA

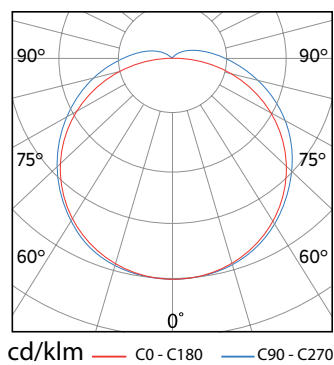



# ILUMINACIÓN ENVOLVENTE



## SLL-360

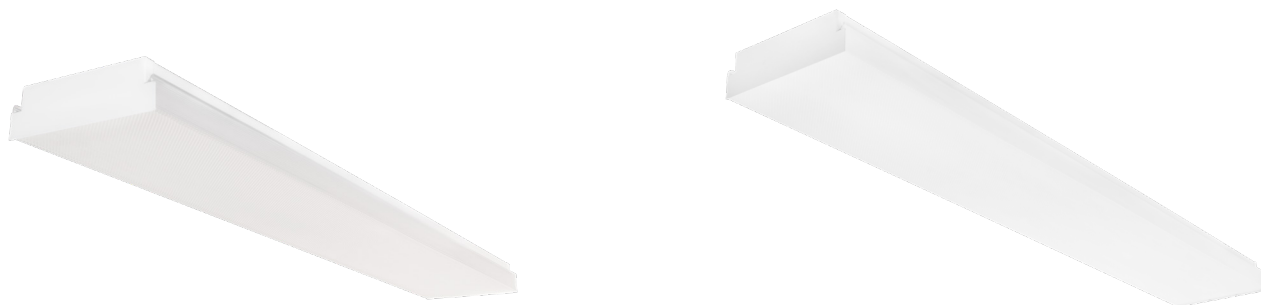

### CARACTERÍSTICAS

POTENCIAS	12W - 72W
RANGO DE LÚMENES	2,100 - 10,080
IRC	≥80
VOLTAJE	120 - 277 V~
COLOR	4000 K y 5000 K
GARANTÍA	10 años

### DIMENSIONES

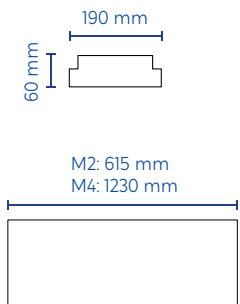

### OPCIONES DE DIFUSOR

- Mica opalina (MO)
- Mica prismática traslucida (MP)

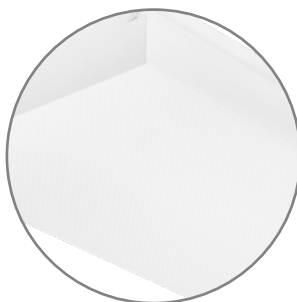

MO



MP





## SPD



Spot LED tipo downlight de alta eficiencia diseñado para empotrar en aplicaciones de alto montaje en interior o exterior gracias a su alto grado de protección.





## SPD



### CARACTERÍSTICAS

POTENCIAS	40W, 50W y 60W
RANGO DE LÚMENES	6,000 - 9,000
IRC	≥80
PROTECCIÓN	IP65
VOLTAJE	120 - 277 V~
COLOR	3000 K, 4000 y 5000 K
GARANTÍA	7 años

### DIMENSIONES

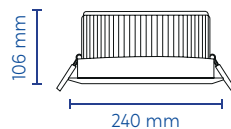

### OPCIONES DE DIFUSOR

- Acrílico esmerilado plano
- Lente cóncavo



## SPT



## CARACTERÍSTICAS

POTENCIAS	14W, 16W, 18W, 20W
RANGO DE LÚMENES	1,800 - 2,500
IRC	≥70
PROTECCIÓN	IP40
VOLTAJE	120 - 277 V~
COLOR	4000 y 5000 K
GARANTÍA	10 años

## DIMENSIONES

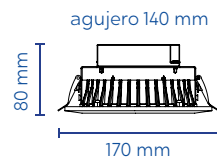

## ACCESORIOS

- Driver de emergencia
- Automatización SupraLink
- Sensor de presencia



# UNIK



## CARACTERÍSTICAS

POTENCIAS	20W - 98W
RANGO DE LÚMENES	2,000 - 12,600
IRC	≥80
VOLTAJE	120 - 277 V~
COLOR	3000 K, 4000 K y 5000 K
GARANTÍA	7 años

## DIMENSIONES

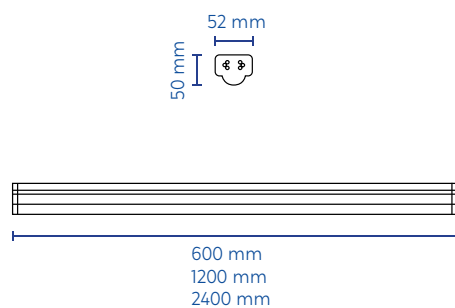

## ACCESORIOS

- Driver de emergencia
- Kit para suspender

## OPCIONES

- Difusor opalino
- Difusor traslucido

## MÉTODO TANDEM

Conecta en fila UNIK para lograr una iluminación uniforme a lo largo.





421<sup>36</sup>

-29%

შპს "საქონელი"

საფრინველი, ხაჭაპური, ყაჭაპური, ხაჭაპური, ყაჭაპური

მწიფე, მწიფე, ყაჭაპური, ხაჭაპური, ყაჭაპური

საფრინველი

117,89

177,99

74

189,99

159

75

38

## LTC

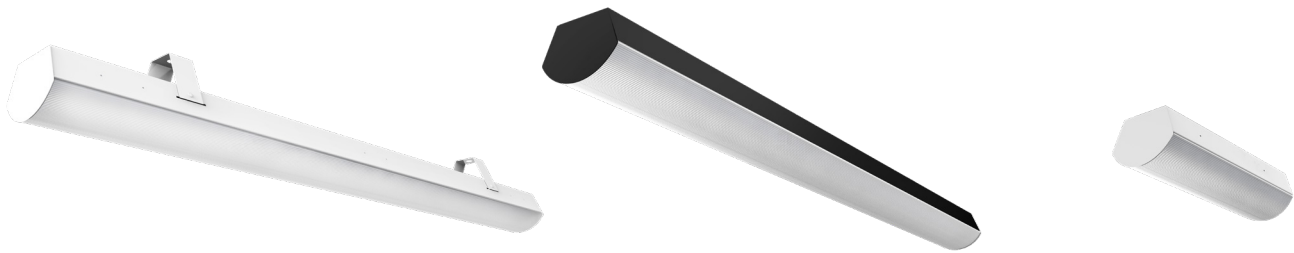

Disponible en color blanco y en negro

## CARACTERÍSTICAS

POTENCIAS	18W, 24W, 30W, 47W, 60W, 72W, 94W
RANGO DE LÚMENES	2,400 - 12,100
IRC	≥80
PROTECCIÓN	IP40
VOLTAJE	120 - 277 V~
COLOR	4000 y 5000 K
GARANTÍA	10 años

## DIMENSIONES

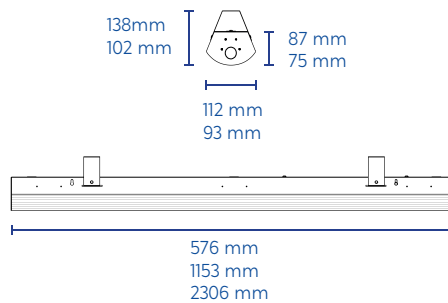

## ACCESORIOS

- Driver de emergencia
- Kit para suspender
- Kit para sobreponer
- Automatización SupraLink

## OPCIONES DE DIFUSOR

Difusor de forma semicircular con textura estriada. Disponible en 11 y 9 cm de amplitud.







# HBF



## CARACTERÍSTICAS

POTENCIAS	40W - 150W
RANGO DE LÚMENES	6,000 - 22,500
IRC	≥80
VOLTAJE	120 - 277 V~
COLOR	3000 K, 4000 K y 5000 K
GARANTÍA	7 años

## DIMENSIONES

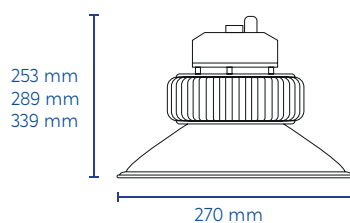

## OPCIONES

- Reflector de 60°
- Reflector de 100°



**HBK****CARACTERÍSTICAS**

POTENCIAS	40W - 150W
RANGO DE LÚMENES	6,000 - 22,500
IRC	≥80
VOLTAJE	120 - 277 V~
COLOR	3000 K, 4000 K y 5000 K
GARANTÍA	7 años

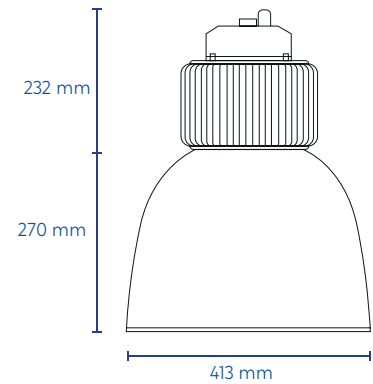
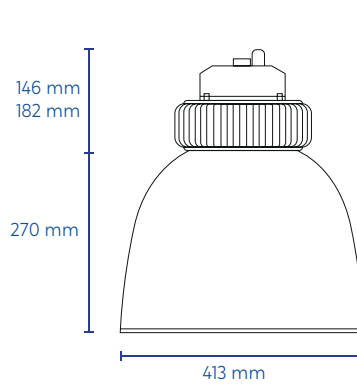
**DIMENSIONES**

Todos nuestros productos cuentan con certificación NOM.  
Supra Desarrollos Tecnológicos se reserva el derecho de modificar la información presentada sin previo aviso y no se hace responsable por errores u omisiones en este documento.

# MALL



## CARACTERÍSTICAS

POTENCIA	44W
RANGO DE LÚMENES	4,300
IRC	≥80
VOLTAJE	120 - 277 V~
COLOR	4000 y 5000 K
GARANTÍA	10 años

## DIMENSIONES

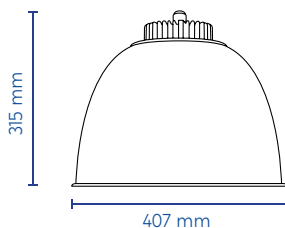

## ACCESORIOS

- Driver de emergencia
- Automatización SupraLink
- Sensor de presencia



## CC-SE-900L



## CARACTERÍSTICAS

- Voltaje de operación: 120-277V
- Batería recargable de 4.8V de larga vida y libre de mantenimiento
- Iluminación de emergencia con mínimo 90 minutos de duración

## DIMENSIONES

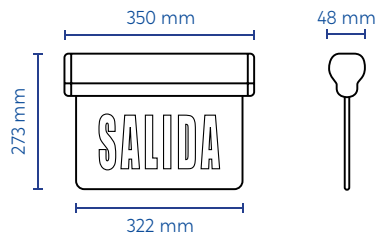

## CC-SE-860L



### CARACTERÍSTICAS

- Voltaje de operación: 120-277V
- Batería Ni-Cd 3.6 V 900 mAh
- Iluminación de emergencia con mínimo 90 minutos de duración



### DIMENSIONES

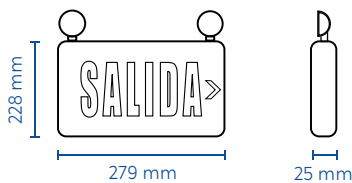

## CC-SE-100L



### CARACTERÍSTICAS

- Voltaje de operación: 120 V~
- Batería Ni-Cd 3.6 V 900 mAh
- Iluminación de emergencia con mínimo 90 minutos de duración



### DIMENSIONES

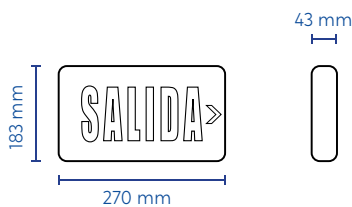

## CC-SE-600L



### CARACTERÍSTICAS

- Voltaje de operación: 120-277V
- Batería Ni-Cd recargable de larga vida útil
- Cambio automático a modo emergencia al cortar suministro eléctrico
- Iluminación hasta 90 min.
- 120 lm (1.2 W c/ cabezal)

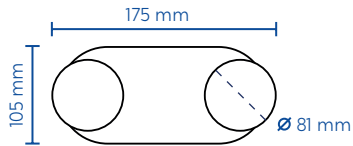

## CC-SE-500L

### CARACTERÍSTICAS

- Voltaje de operación: 120-277V
- Batería LeFePO4 6.4 V 1500 mA
- Iluminación de emergencia con mínimo 90 minutos de duración
- 400 lúmenes a 4 W

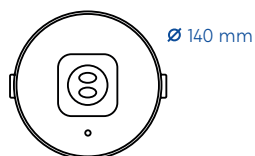
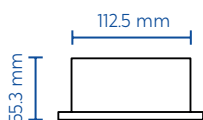

- Kit de montaje para sobreponer



**SupraLink** es nuestro sistema para el control y administración de iluminación, genera ahorros mayores al 70% en el consumo eléctrico, reduce el mantenimiento y extiende la vida de tus luminarias





BLUETOOTH  
5.1





# SUPRALINK

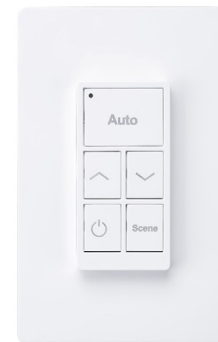

## Iluminación programada

Programa encendido, apagado y atenuación, ajusta los niveles de iluminación por luminaria o grupo de luminarias.

## Fácil de usar

La aplicación SupraLink es muy fácil de utilizar, está diseñada para ser intuitiva, solo descárgala y comienza a agregar las luminarias por medio de Bluetooth. designar Administrador e Invitado y mucho más.

## Configura sensores

Además de configurar horarios de iluminación puedes configurar sensores de presencia o sensores sensibles a la luz natural, de esta forma los niveles de iluminación de tus luminarias se atenuan conforme al aprovechamiento de la luz del día.

## Versatilidad

Modelos de sensores diseñados para aplicaciones de alto y bajo montaje.

## Accesorios

Complementa SupraLink con nuestro interruptor inteligente **SLSW**, controla y administra tu iluminación aun sin tener la aplicación, con un interruptor sensible al tacto, puede instalarse en pared y remover la botonera para utilizarse como control remoto.





**ILUMINANDO  
HACIA EL FUTURO**

# SENSORES

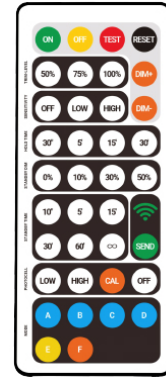

## Sensores de presencia

Sensores completamente listos para ser instalados y operan con cualquier luminaria que tenga modalidad de atenuación (0-10V DC).

## Tecnología PIR

Sensores de presencia infrarojos, de bajo consumo.

Modelos diseñados para alto y bajo montaje.

## Beneficios

- Encendido, atenuado y apagado automático de las luminarias.
- Aprovechamiento de la luz solar.
- Reducción del consumo energético.
- Alarga la vida de tus luminarias.

## APERTURA DE LENTE

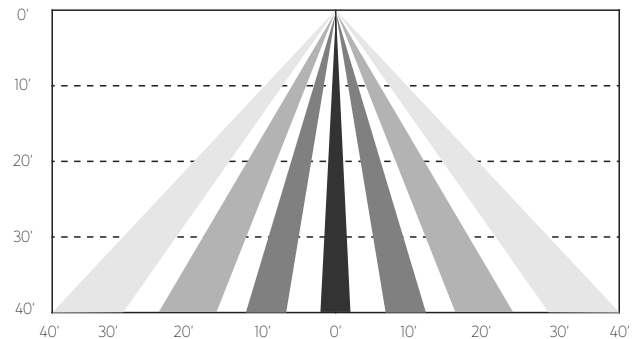
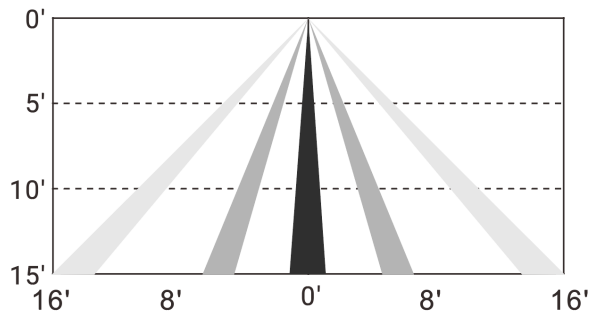

Modelo: SSDLMHB  
para alto montaje

**MAYOR EFICIENCIA  
EN TODAS TUS ÁREAS**



## LIZ10

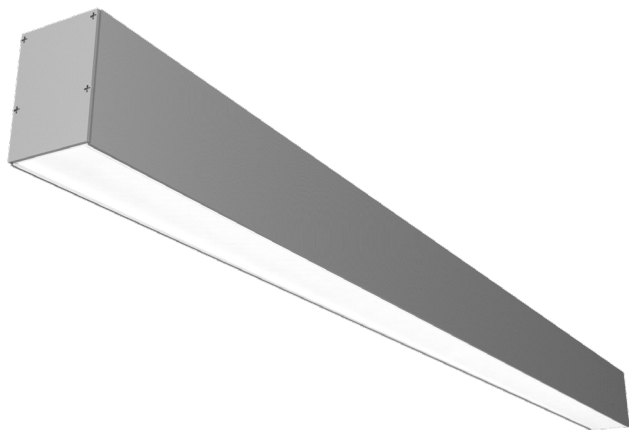

## DESCRIPCIÓN

Perfil LED fabricado en aluminio, con difusor de mica opalina, diseñado para instalar de forma suspendida o sobrepuesta al ras, emite luz difusa directa.

## CARACTERÍSTICAS

RANGO DE LÚMENES	M1: 2,317 - 3,411 M2: 2,296 - 6,644
PROTECCIÓN	IP40
VOLTAJE	120 - 277 V~
COLOR	3000, 4000 y 5000 K
GARANTÍA	7 años

## DIMENSIONES

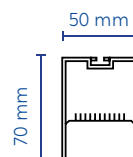

## LARGO

M1: 1 metro  
M2: 2 metros

IP40

120-277  
VAC

3000  
4000 K  
5000



# LIZ20

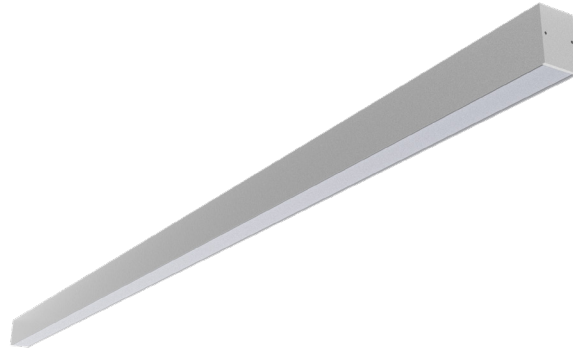

## DESCRIPCIÓN

Perfil LED fabricado en aluminio, con difusor de mica opalina, diseñado para instalar de forma suspendida, emite luz difusa de forma directa e indirecta simultáneamente.

## CARACTERÍSTICAS

RANGO DE LÚMENES	M1: 2,239 - 4,191 M2: 4,153 - 7,958
PROTECCIÓN	IP40
VOLTAJE	120 - 277 V~
COLOR	3000, 4000 y 5000 K
GARANTÍA	7 años

## DIMENSIONES

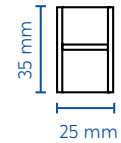

## LARGO

M1: 1 metro  
M2: 2 metros



## LIZ30



## DESCRIPCIÓN

Perfil LED de aluminio para empotrar en techo o pared, emite luz difusa de forma directa por medio de su difusor de mica opalina.

## CARACTERÍSTICAS

RANGO DE LÚMENES	M1: 1,859 - 2,737 M2: 1,843 - 5,331
PROTECCIÓN	IP40
VOLTAJE	120 - 277 V~
COLOR	3000, 4000 y 5000 K
GARANTÍA	7 años

## DIMENSIONES

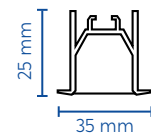

## LARGO

M1: 1 metro  
M2: 2 metros





# LIZ40



## DESCRIPCIÓN

Perfil LED con alto grado de protección (IP65) fabricado en aluminio, con difusor de mica opalina, diseñado para empotrar, emite luz difusa de forma directa.

## CARACTERÍSTICAS

RANGO DE LÚMENES	M1: 1,580 - 2,196 M2: 2,183 - 6,588
PROTECCIÓN	IP65
VOLTAJE	120 - 277 V~
COLOR	3000, 4000 y 5000 K
GARANTÍA	7 años

## DIMENSIONES

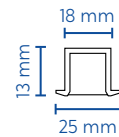

## LARGO

M1: 1 metro  
M2: 2 metros



# LIZ60



## DESCRIPCIÓN

Perfil LED fabricado en aluminio, con difusor de mica opalina, útil para empotrar o sobreponer, emite una iluminación envolvente.

## CARACTERÍSTICAS

RANGO DE LÚMENES	M1: 2,349 - 3,505 M2: 4,246 - 6,463
PROTECCIÓN	IP40
VOLTAJE	120 - 277 V~
COLOR	3000, 4000 y 5000 K
GARANTÍA	7 años

## DIMENSIONES

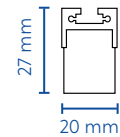

## LARGO

M1: 1 metro  
M2: 2 metros



## LIZ50

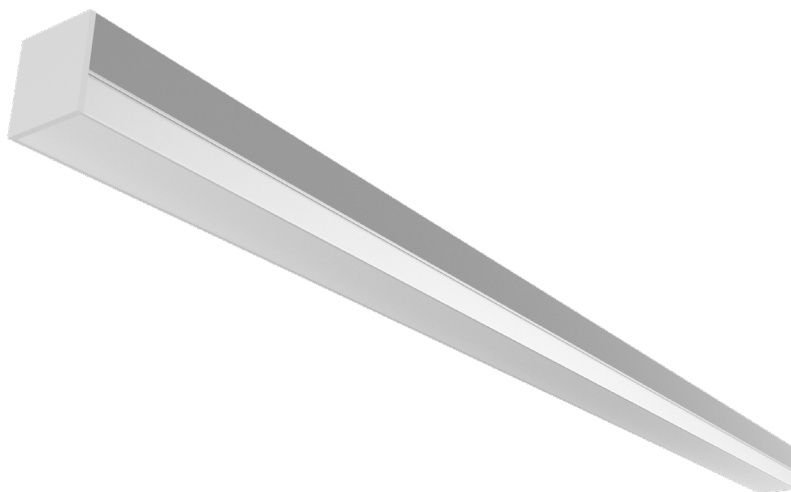

## DESCRIPCIÓN

Perfil LED fabricado en aluminio, con difusor de mica opalina, diseñado para suspender, emite una iluminación envolvente.

## CARACTERÍSTICAS

RANGO DE LÚMENES	M1: 1,623 - 2,422 M2: 2,934 - 5,497
PROTECCIÓN	IP40
VOLTAJE	120 - 277 V~
COLOR	3000, 4000 y 5000 K
GARANTÍA	7 años

## DIMENSIONES

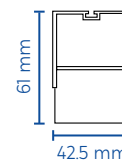

## LARGO

M1: 1 metro  
M2: 2 metros



# TOM40



## DESCRIPCIÓN

Luminaria lineal de instalación suspendida, emite una iluminación envolvente directa e indirecta simultáneamente, cuenta con difusor mica opalina.

## CARACTERÍSTICAS

POTENCIA	40W
RANGO DE LÚMENES	3,589
IRC	≥80
PROTECCIÓN	IP40
VOLTAJE	100 - 277 V~
COLOR	4000 K
GARANTÍA	7 años

## DIMENSIONES

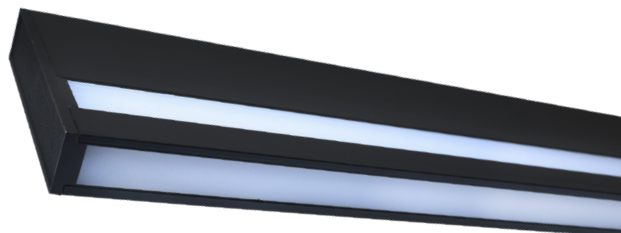
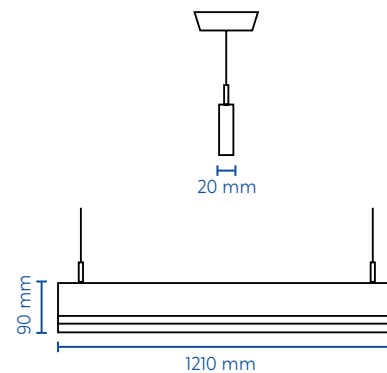

- IP40
- 120-277 VAC
- Light fixture icon
- Desk lamp icon
- Table icon
- Chair icon



## TOM10

Diseñada para suspender, de iluminación directa con difusor mica opalina.

POTENCIA	40W
RANGO DE LÚMENES	3,565
IRC	≥80
PROTECCIÓN	IP40
VOLTAJE	100 - 277 V~
COLOR	4000 K
GARANTÍA	7 años

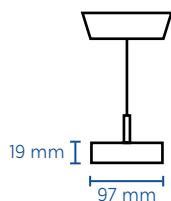

Largo: 1200 mm



## TOM20

Diseñada para suspender, de iluminación directa e indirecta con difusor mica opalina.

POTENCIA	40W
RANGO DE LÚMENES	4,577
IRC	≥80
PROTECCIÓN	IP40
VOLTAJE	100 - 277 V~
COLOR	4000 K
GARANTÍA	7 años

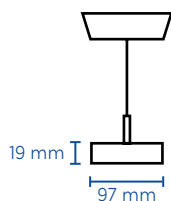

Largo: 1200 mm

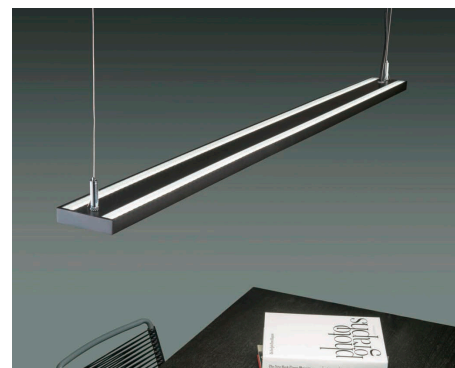

# TOM30



Luminaria de media luna, diseñada para suspender, de iluminación directa e indirecta con difusor mica opalina.

## CARACTERÍSTICAS

POTENCIA	40W
RANGO DE LÚMENES	2,850
IRC	≥80
PROTECCIÓN	IP40
VOLTAJE	100 - 277 V~
COLOR	4000 K
GARANTÍA	7 años

## DIMENSIONES

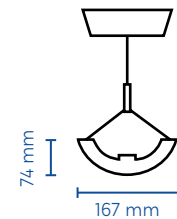

Largo: 1200 mm





## CLINELD02003A



COLORES  
DISPONIBLES:



POTENCIAS DISPONIBLES	20W
LÚMENES	1,600
IRC	≥80
DIMENSIONES	110*106*97 mm
VOLTAJE	100 - 240 V~
COLOR	3000 K, 4000 K, 5000 K

## CLINELD015014H



COLORES  
DISPONIBLES:



POTENCIA	15W
LÚMENES	1,200
IRC	≥80
DIMENSIONES	D100*H30 mm
VOLTAJE	100 - 240 V~
COLOR	3000 K, 4000 K, 5000 K
ROTACIÓN	35°

## CLINRLD02527D



COLORES  
DISPONIBLES:



POTENCIA	25W
LÚMENES	2,000
IRC	≥80
DIMENSIONES	D120*H80 mm
VOLTAJE	100 - 240 V~
COLOR DE TEMPERATURA	3000 K, 4000 K, 5000 K
ROTACIÓN	10° / 20° / 30°

## CUBIX

COLORES  
DISPONIBLES:



POTENCIAS DISPONIBLES	8W y 18W
LÚMENES	720 y 1,620
IRC	≥90
DIMENSIONES	75*75*40 mm 131*49*54 mm
VOLTAJE	100 - 277 V~
COLOR	3000 K, 4000 K

## CLINELD02004B CLINELD03004C

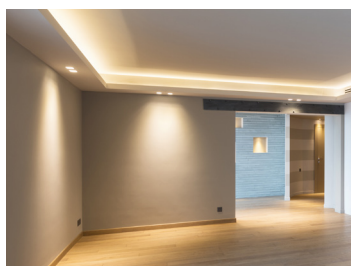

POTENCIA	20W y 30W
LÚMENES	1,600 y 2,400
IRC	≥80
DIMENSIONES	167*98*86 mm 237*98*86 mm
VOLTAJE	100 - 240 V~
COLOR DE TEMPERATURA	3000 K, 4000 K, 5000 K

COLORES  
DISPONIBLES:



## CLINELD020B010M

COLORES  
DISPONIBLES:



POTENCIAS DISPONIBLES	20W
LÚMENES	2,000
IRC	≥80
DIMENSIONES	D188*H68 mm
VOLTAJE	100 - 240 V~
COLOR	3000 K, 4000 K, 5000 K

## CLINELD02505A CLINELD05005B



COLORES  
DISPONIBLES:



POTENCIAS DISPONIBLES	25W y 50W
LÚMENES	2,000 y 4,000
IRC	≥80
DIMENSIONES	D83*H130/210 mm
VOLTAJE	100 - 240 V~
COLOR	3000 K, 4000 K, 5000 K

## CLINSLD01221D

COLORES  
DISPONIBLES:



POTENCIA	12W
LÚMENES	960
IRC	≥80
DIMENSIONES	D67*H230 mm D67*H350 mm D67*H600 mm
VOLTAJE	100 - 240 V~
COLOR DE TEMPERATURA	3000 K, 4000 K, 5000 K
ÁNGULO DE APERTURA	10° / 24° / 38°

## CLINRLD02501326K

COLORES  
DISPONIBLES:



POTENCIA	25W
LÚMENES	2,000
IRC	≥80
DIMENSIONES	D80*H205 mm
VOLTAJE	100 - 240 V~
COLOR DE TEMPERATURA	3000 K, 4000 K, 5000 K
ROTACIÓN	10° / 20° / 30°

## CLEXELD003C120S29I

COLORES  
DISPONIBLES:

S



POTENCIA	3W
LÚMENES	30
DIMENSIONES	58*43 mm
VOLTAJE	120 - 240 V~
COLOR DE TEMPERATURA	3000 K
PROTECCIÓN	IP67

## CLEXELD003C120S29I

COLORES  
DISPONIBLES:

So



POTENCIA	18W
LÚMENES	528
DIMENSIONES	173*90 mm
VOLTAJE	120 - 240 V~
COLOR DE TEMPERATURA	2700 K, 6500 K
PROTECCIÓN	IP67 / IK07



## CLEXELD00208029D



COLORES  
DISPONIBLES:



POTENCIA	2.4W
LÚMENES	68
DIMENSIONES	106*171*65 mm
VOLTAJE	120 - 240 V~
COLOR DE TEMPERATURA	2700 K, 6500 K
PROTECCIÓN	IP65 / IK10

## CLEXELD00208029C



COLORES  
DISPONIBLES:



POTENCIA	2.3W
LÚMENES	66
DIMENSIONES	171*106*65 mm
VOLTAJE	120 - 240 V~
COLOR DE TEMPERATURA	2700 K, 6500 K
PROTECCIÓN	IP65 / IK10

## CLEXELD003120S29H



COLORES  
DISPONIBLES:



POTENCIA	3W
LÚMENES	133
DIMENSIONES	180*58*90 mm
VOLTAJE	120 - 240 V~
COLOR DE TEMPERATURA	2700 K, 6500 K
PROTECCIÓN	IP65 / IK08

## CLEXELD00308029A

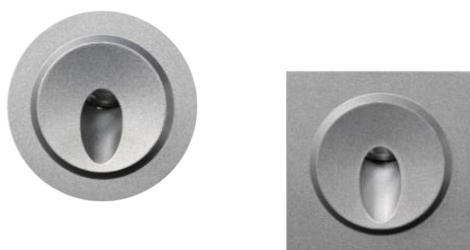

COLORES  
DISPONIBLES:



POTENCIA	3W
LÚMENES	66 / 75
IRC	≥80
DIMENSIONES	80*46 mm
VOLTAJE	120 - 240 V~
COLOR DE TEMPERATURA	2700 K, 6500 K
PROTECCIÓN	IP65 / IK09

## CLEXSLD01136G



COLORES  
DISPONIBLES:



POTENCIA	11W
LÚMENES	1,000
IRC	≥80
DIMENSIONES	166*166*300 mm 166*166*500 mm 166*166*800 mm
VOLTAJE	100 - 277 V~
COLOR DE TEMPERATURA	2700 K, 6500 K
PROTECCIÓN	IP65

## CLEXSLD01336O

COLORES  
DISPONIBLES:



POTENCIA	11W
LÚMENES	1,200
IRC	≥80
DIMENSIONES	150*150*300 mm 150*150*500 mm 150*150*800 mm
VOLTAJE	100 - 2277 V~
COLOR DE TEMPERATURA	2700 K, 6500 K
PROTECCIÓN	IP65

## BOX



COLORES  
DISPONIBLES:



POTENCIA	10,5W
LÚMENES	950
DIMENSIONES	120*200*10 mm
VOLTAJE	100 - 277 V~
COLOR DE TEMPERATURA	2700 K, 6500 K
PROTECCIÓN	IP65

## CLEXSLD00738O CLEXSLD01338M



COLORES  
DISPONIBLES:



POTENCIA	7W
LÚMENES	570
DIMENSIONES	138*44 mm
VOLTAJE	100 - 277 V~
COLOR DE TEMPERATURA	2700 K, 6500 K
PROTECCIÓN	IP54

## CLEXSLD01138J

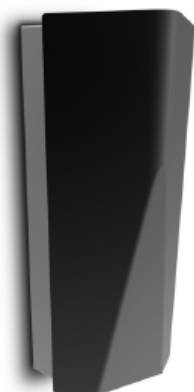

COLORES  
DISPONIBLES:



POTENCIA	11W
LÚMENES	1,000
DIMENSIONES	106*200*62 mm
VOLTAJE	100 - 277 V~
COLOR DE TEMPERATURA	2700 K, 6500 K
PROTECCIÓN	IP65



# LUZ UV-C

Este tipo de luz ultravioleta, es la única con capacidad desinfectante. Nuestras luminarias UV-C cuentan con certificaciones que avalan su 99.9% de eficiencia eliminando virus, bacterias y hongos.



## HEALIX-UVC

Lámpara portátil útil para desinfectar superficies. Diseño ligero, incluye control remoto, con función de apagado automático y programación de 15, 30 y 60 minutos.

RADIACIÓN UVC	4,500 mW
RADIACIÓN UVC @100H	4,140 mW
LONGITUD DE ONDA PICO	254 nm
INTENSIDAD UV	453 $\mu\text{W}/\text{m}^2$
VIDA ÚTIL	2000 hrs

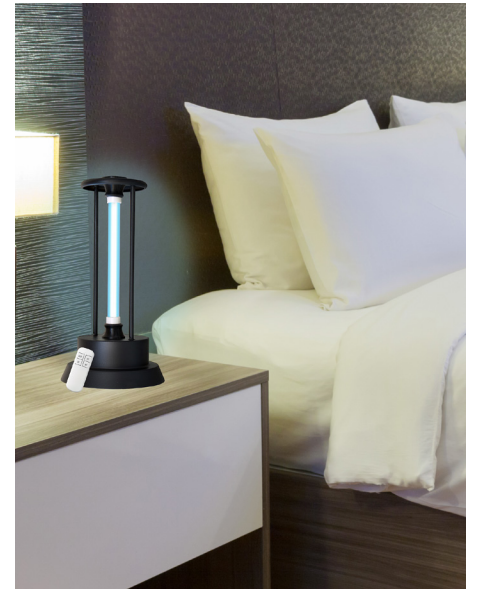

## UVC-MOV

Lámpara tipo pedestal, con ruedas para trasladarlo fácilmente. Cuenta con control remoto para encendido y apagado.

POTENCIA	160W
RADIACIÓN UV-C	40,800 mW
RADIACIÓN UVC @100H	37,500mW
LONGITUD DE ONDA PICO	254 nm
INTENSIDAD UVC	3,510 $\text{mW}/\text{m}^2$
VOLTAJE	120 ó 120 - 277 V~
GARANTÍA	1 año



## UVC-HB

Lámpara de alto montaje para desinfectar grandes áreas. Mantén tu industria libre de virus con el uso de luz UV-C.

POTENCIA	240W y 320W
RADIACIÓN UV-C	43,200 y 57,600 mW
RADIACIÓN UVC @100H	33,782 y 45,043 mW
LONGITUD DE ONDA PICO	254 nm
INTENSIDAD UVC	11,600 mW/m <sup>2</sup> (max)
VOLTAJE	120 - 277 V~
GARANTÍA	1 año

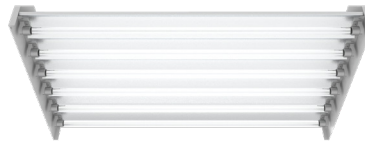
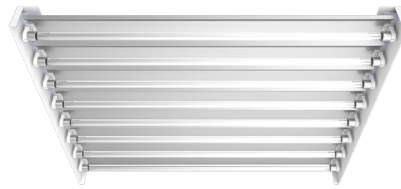

Modelos con 6 y 8 tubos UV-C



## UVC-LB

Lámpara de bajo montaje para instalar en plafón, mantén una desinfección periódica en tus instalaciones.

POTENCIA	60, 80, 120 y 160W
RADIACIÓN UV-C	10,800 - 28,800 mW
RADIACIÓN UVC @100H	9,720-26,490 mW
LONGITUD DE ONDA PICO	254 nm
INTENSIDAD UVC	2,447 - 5,591 mW/m <sup>2</sup>
VOLTAJE	120 ó 120 - 277 V~
GARANTÍA	1 año



Modelos de 2 y 4 pies

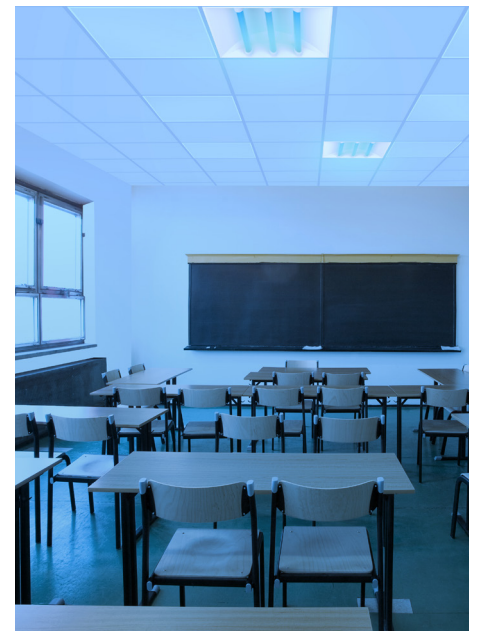

## SLUV-410C

Lámpara lineal, diseñada para sobreponer. Ideal para mostradores o pasillos. Desinfecta de forma efectiva a bajo montaje.

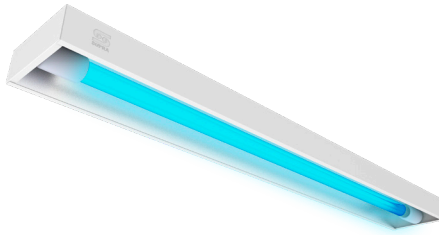

POTENCIA	40W
RADIACIÓN UV-C	7,200 mW
RADIACIÓN UVC @100H	6,624 mW
LONGITUD DE ONDA PICO	254 nm
INTENSIDAD UVC	1,683 mW/m <sup>2</sup>
VOLTAJE	110 V~
GARANTÍA	1 año

## UVC-AIR

Solución para instalar en sistemas de ventilación, por lo que no es necesario desocupar el área para desinfectar.

Arreglos de 2 y 4 tubos para adaptar en tu instalación.

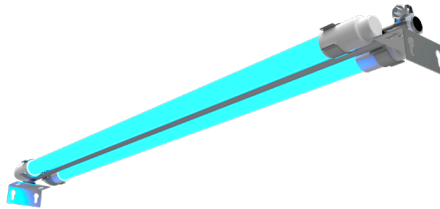

POTENCIA	40W y 80W
RADIACIÓN UV-C	12,000 - 24,000 mW
RADIACIÓN UVC @100H	11,040 - 22,080 mW
LONGITUD DE ONDA PICO	254 nm
INTENSIDAD UVC	2,520 mW/m <sup>2</sup> (max)
VOLTAJE	120 ó 120 - 277 V~
GARANTÍA	1 año

## UVC-UP

Operando las 24 horas del día, estas lámparas montadas en la pared o suspendidas, usan luz ultravioleta en la longitud de onda de la banda C germicida de 254 nm, por lo que no es necesario desocupar el área para desinfectar.

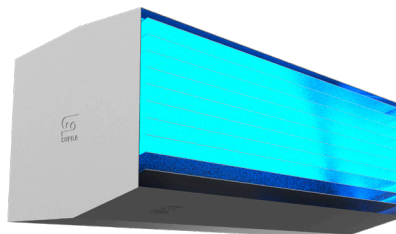

POTENCIA	20W
RADIACIÓN UV-C	6,000 mW
RADIACIÓN UVC @100H	5,520 mW
LONGITUD DE ONDA PICO	254 nm
INTENSIDAD UVC	210 mW/m <sup>2</sup>
VOLTAJE	120 ó 120 - 277 V~
GARANTÍA	1 año



**SUPRA**  
**SOLAR**

# HSL SOLAR



## COMPONENTES

- Baterías: Acumuladores sellados de ciclo profundo, libres de mantenimiento.
- Controlador: MPPT seguidor de punto de máxima potencia.
- Gabinetes: Cajas metálicas con cerradura para resguardo de componentes.

## RENDIMIENTO DE BATERÍA

VRLA-AGM  
(1050 ciclos)

12 horas  
encendido  
continuo

VRLA-GEL  
(2600 ciclos)

12 horas  
encendido  
con etapa de  
ahorro de  
energía al 50%  
de 6 hrs.

## MODELOS Y POTENCIAS

HSL4

28W, 40W, 45W,  
56W, 61W, 72W,  
78W, 90W, 96W

## OPCIONES DE INSTALACIÓN

Luminaria en brazo de poste con panel solar y batería

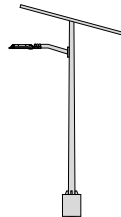

PISO

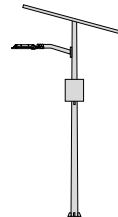

MEDIO



SUBTERRÁNEO



# SUP



## COMPONENTES

- Panel solar monocristalino, integrado en la luminaria.
- Sensor de presencia
- Equipo hermético protegido contra polvo y agua (IP65).
- Módulos LED 3030 de alta eficiencia.
- Batería de litio (LiFePo) de larga durabilidad.

## RENDIMIENTO DE BATERÍA

<b>DURACIÓN</b>	3.-5 días, con la batería totalmente cargada
<b>TIEMPO DE CARGA</b>	6-8 horas
<b>TASA DE CONVERSIÓN</b>	Alta 19 - 20%

## CARACTERÍSTICAS

- 120W de potencia
- 18,000 lúmenes
- Ahorro de energía y baja emisión de CO2.
- Diseño con inclinación de 15° para drenar la lluvia.
- Fácil instalación y nulo mantenimiento.

## DIMENSIONES

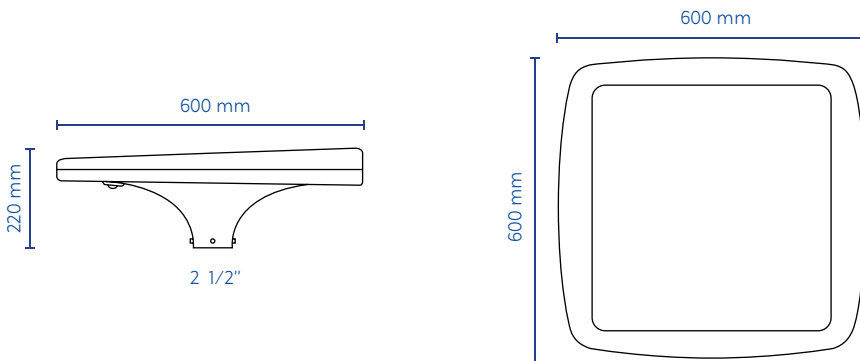





# GRETA



## COMPONENTES

- Panel solar Bifacial, capta los rayos de sol directos e indirectos. Genera 30% más de energía que un panel tradicional.
- Alta eficiencia, alcanzando más de 200 lm/W
- Módulos LED desacoplables para rotar hasta 60°.
- Brazo de ángulo ajustable para instalar en punta de poste.

## CARACTERÍSTICAS

Potencias	Modelos de 10 - 60 W
Batería de litio	153.6 Wh a 537.6 Wh (acorde a potencia de luminaria)
Vida útil	5 años

## ACCESORIOS

- Alarma
- Cámara de seguridad
- AC/CC
- Gestión de IoT
- Protector contra sobre tensiones de 4KV
- App inteligente

Descubre más características en la ficha técnica.

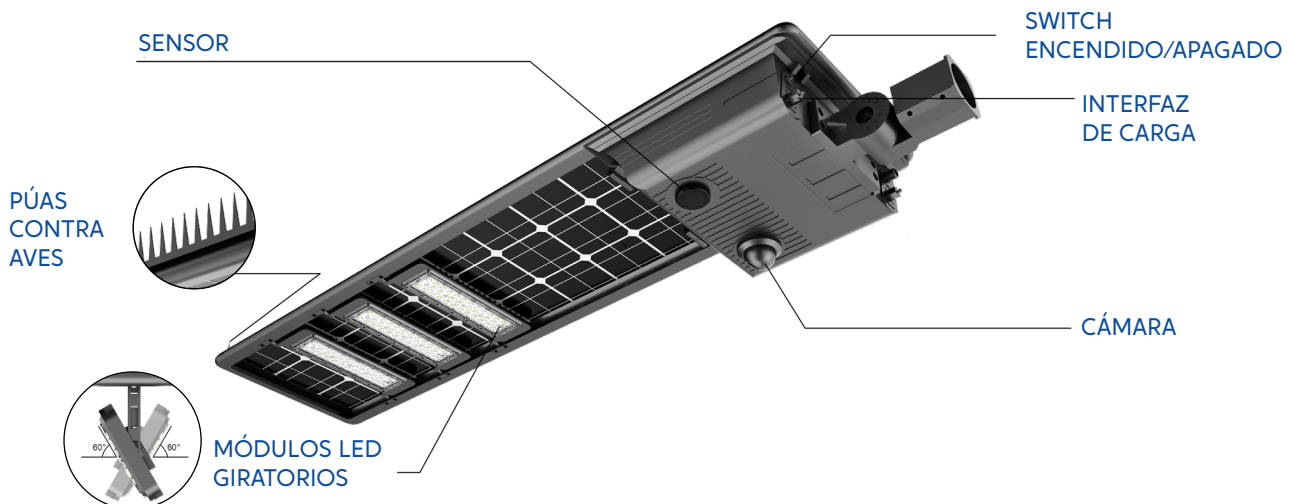



# SUNEL



## DESCRIPCIÓN

Luminaria punta de poste con sistema fotovoltaico integrado (all in one). Fabricada en aluminio. Cuenta con fotocelda y esta montada sobre un brazo de ángulo ajustable.

## CARACTERÍSTICAS

POTENCIA	40W -120W
RANGO DE LÚMENES	4,000 - 11,528
PANEL SOLAR (MONO)	42W - 120W
CAPACIDAD DE LA BATERÍA	346, 460 y 691 WH
PROTECCIÓN	IP65
COLOR	6000 K
GARANTÍA	5 años

## PANEL SOLAR INTEGRADO

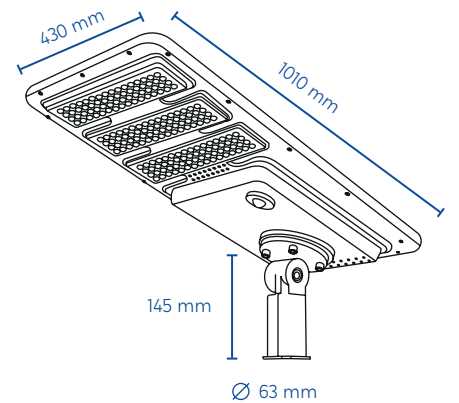
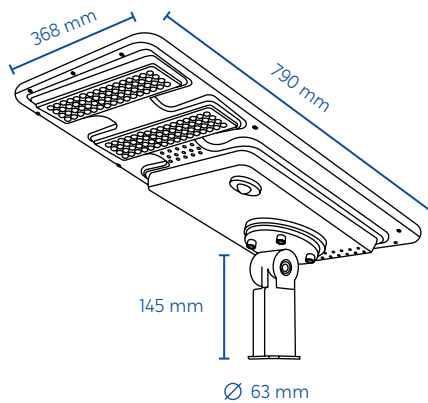
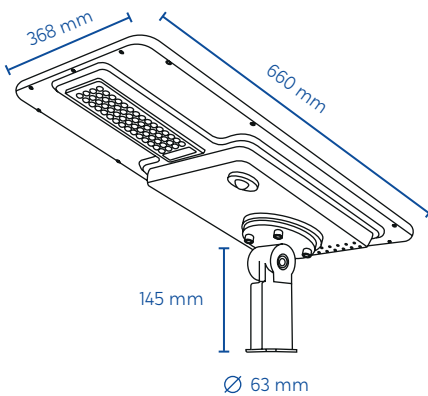



# CARPORT

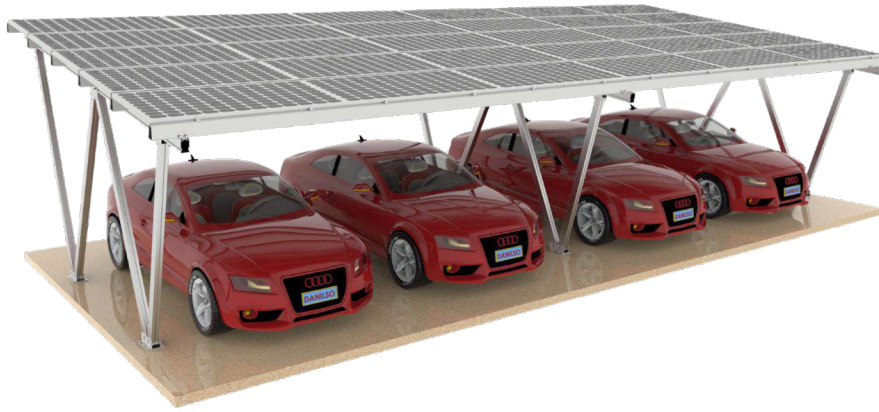

## DESCRIPCIÓN

Mejora el aprovechamiento de tu espacio de estacionamiento para generar energía eléctrica. Nuestro sistema de montaje fotovoltaico CARPORT esta fabricado en aluminio 6005-T5, lo que le brinda alta resistencia y durabilidad.

## CARACTERÍSTICAS

SITIO DE INSTALACIÓN	Campo abierto o suelo
ÁNGULO DE INCLINACIÓN	5° ~ 60°
VELOCIDAD MÁX. DEL VIENTO	198 km/h
CARGA MÁX. DE NIVEL	140 kg/m <sup>2</sup>
GARANTÍA	12 años

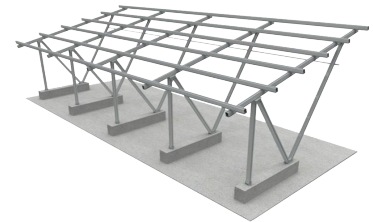

No incluye sistema fotovoltaico. Consulte con un agente de ventas para completar su solución sustentable.



## MONOPOSTE



Arreglos disponibles para 4, 6 y 8 paneles

### DESCRIPCIÓN

Nuestro arreglo MONOPOSTE, adopta una alta resistencia por su material de aluminio AL6005-T5 & Q235. Es adecuado para diferentes regiones de vientos y nevadas fuertes. Su instalación es simple y rápida ya que algunos de sus componentes están previamente montados desde su fabricación.

### CARACTERÍSTICAS

SITIO DE INSTALACIÓN	Campo abierto o suelo
ÁNGULO DE INCLINACIÓN	5° ~ 60°
VELOCIDAD MÁX. DEL VIENTO	216 km/h
CÁRGA MÁX. DE NIVEL	145 kg/m <sup>2</sup>
GARANTÍA	10 años

### CERTIFICADO

· Estándar: TUV&AS-NZS 1170



## SOLUCIONES CON ENERGÍA SOLAR

Genere su propia energía y ahorre con un sistema solar interconectado a la red eléctrica. Contamos con personal capacitado para orientarlo con la mejor solución para su tipo de instalación, sin importar que ésta sea doméstica, industrial o en áreas remotas sin acceso a la red eléctrica.





[www.supradesarrollos.com](http://www.supradesarrollos.com)

**MATRIZ MONTERREY**

Antireeleccionistas #120A Col. Antonio I. Villarreal  
C.P 64390 Monterrey, N.L México

 81 8676-0127 / 81 8676-0147 / 81 8676-0142

[info@supradesarrollos.com](mailto:info@supradesarrollos.com)